

SHARP®

LC-40LB480U

Full HD LED 1080p TV

USER GUIDE



HD

40"
CLASS

(40" Diagonal)

SHARP®

Contents

CHILD SAFETY	1
Important Safety Instructions	2
WARNING	2
CAUTION	3
Introduction	4
CEC Control	4
DTS TruSurround™	4
Game mode	4
Installing the stands or wall-mount bracket	5
Installing the stands	5
Installing a wall-mount bracket	6
TV components	8
Package contents	8
Front	8
Left side	9
Right side	10
Remote control	11
What connection should I use?	12
Connecting a cable or satellite box	13
HDMI (best)	13
AV (good)	14
Coaxial (good).....	15
Connecting an antenna or cable TV (no box)	16
Connecting a DVD or Blu-ray player	17
HDMI (best)	17
AV (good)	18
Connecting a game console	19
HDMI (best)	19
AV (good)	20
Connecting a computer	21
HDMI (best)	21
Connecting a USB flash drive	22
Connecting headphones	23

- Connecting external speakers or a sound bar24
 - Digital audio 24
 - Analog audio 25
- Connecting a home theater system with multiple devices26
- Connecting power27
- Using the remote control28
 - Installing remote control batteries 28
 - Aiming the remote control 28
 - Programming universal remote controls 29
 - Viewing universal remote control codes 29
- Turning on your TV for the first time30
- Understanding the basics32
 - Turning your TV on or off 32
 - Selecting the video input source 32
 - On-screen menu overview 33
 - Navigating the menus 34
 - Selecting a channel 34
 - Adjusting the volume 34
 - Viewing channel information 34
- Using CEC Control35
 - Turning CEC Control on or off 35
 - Turning Device Auto Power Off on or off 35
 - Turning TV Auto Power On on or off 36
 - Turning Audio Return Channel on or off 36
 - Displaying a list of CEC-compatible devices 37
 - Selecting a CEC-compatible device 37
 - Opening a CEC-compatible device’s root menu 38
- Using a USB flash drive38
 - Switching to USB mode 38
 - Browsing photos 38
 - Viewing favorite photos 39
 - Viewing photos in a slideshow 40
- Adjusting the picture40
 - Adjusting the TV picture 40
 - Automatically adjusting the aspect ratio 42
 - Setting the power on picture mode 42
- Adjusting the sound43
 - Adjusting sound settings 43
 - Selecting the audio out mode 44
 - Playing TV audio only 44

Changing channel settings	45
Automatically scanning for channels	45
Hiding channels	46
Setting up a favorite channel list	46
Viewing a favorite channel	47
Adding or changing a channel label	47
Checking the digital signal strength	48
Setting parental controls	49
Setting or changing the password	49
Blocking unrated TV	50
Setting parental control levels	50
Downloading rating information	52
Locking the power button	53
Using closed captioning	53
Turning closed captioning on or off	53
Selecting the analog closed captioning mode	54
Selecting the digital closed captioning mode	54
Customizing digital closed captioning settings	55
Adjusting time settings	56
Setting the clock	56
Setting the sleep timer	57
Adjusting menu settings	57
Selecting the menu language	57
Turning Input Sensor on or off	58
Labeling an input source	58
Maintenance	59
Cleaning the TV cabinet	59
Cleaning the TV screen	59
Troubleshooting	59
Viewing system information	59
Learning more	59
Updating the TV firmware	60
Restoring settings to the defaults	60
Video and audio	61
Remote control	63
General	63
CEC-compatible device	64
Specifications	67
Legal notices	68
One-year limited warranty - Sharp Televisions	69

CHILD SAFETY

PROPER TELEVISION PLACEMENT MATTERS



THE CONSUMER ELECTRONICS INDUSTRY CARES

- Manufacturers, retailers and the rest of the consumer electronics industry are committed to making home entertainment safe and enjoyable.
- As you enjoy your television, please note that all televisions - new and old- must be supported on proper stands or installed according to the manufacturer's recommendations. Televisions that are inappropriately situated on dressers, bookcases, shelves, desks, speakers, chests, carts, etc., may fall over, resulting in injury.

TUNE IN TO SAFETY

- **ALWAYS** follow the manufacturer's recommendations for the safe installation of your television.
- **ALWAYS** read and follow all instructions for proper use of your television.
- **NEVER** allow children to climb on or play on the television or the furniture on which the television is placed.
- **NEVER** place the television on furniture that can easily be used as steps, such as a chest of drawers.
- **ALWAYS** install the television where it cannot be pushed, pulled over or knocked down.
- **ALWAYS** route cords and cables connected to the television so that they cannot be tripped over, pulled or grabbed.

WALL OR CEILING MOUNT YOUR TELEVISION

- **ALWAYS** contact your retailer about professional installation if you have any doubts about your ability to safely mount your television.
- **ALWAYS** use a mount that has been recommended by the television manufacturer and has a safety certification by an independent laboratory (such as UL, CSA, ETL).
- **ALWAYS** follow all instructions supplied by the television and mount manufacturers.
- **ALWAYS** make sure that the wall or ceiling where you are mounting the television is appropriate. Some mounts are not designed to be mounted to walls and ceilings with steel studs or cinder block construction. If you are unsure, contact a professional installer.
- Televisions can be heavy. A minimum of two people is required for a wall or ceiling mount installation.

MOVING AN OLDER TELEVISION TO A NEW PLACE IN YOUR HOME

- Many new television buyers move their older CRT televisions into a secondary room after the purchase of a flat-panel television. Special care should be made in the placement of older CRT televisions.
- **ALWAYS** place your older CRT television on furniture that is sturdy and appropriate for its size and weight.
- **NEVER** place your older CRT television on a dresser where children may be tempted to use the drawers to climb.
- **ALWAYS** make sure your older CRT television does not hang over the edge of your furniture.

Important Safety Instructions



This symbol indicates that dangerous voltage constituting a risk of electric shock is present within your TV. This label is located on the back of your TV.



This symbol indicates that there are important operating and maintenance instructions in the literature accompanying your TV.

- 1 Read these instructions.
- 2 Keep these instructions.
- 3 Heed all warnings.
- 4 Follow all instructions.
- 5 Do not use this apparatus near water.
- 6 Clean only with dry cloth.
- 7 Do not block any ventilation openings. Install in accordance with the manufacturer's instructions.
- 8 Do not install near any heat sources such as radiators, heat registers, stoves, or other apparatus (including amplifiers) that produce heat.
- 9 Do not defeat the safety purpose of the polarized or grounding-type plug. A polarized plug has two blades with one wider than the other. A grounding type plug has two blades and a third grounding prong. The wide blade or the third prong are provided for your safety. If the provided plug does not fit into your outlet, consult an electrician for replacement of the obsolete outlet.
- 10 Protect the power cord from being walked on or pinched particularly at plugs, convenience receptacles, and the point where they exit from the apparatus.
- 11 Only use attachments/accessories specified by the manufacturer.
- 12 Use only with the cart, stand, tripod, bracket, or table specified by the manufacturer, or sold with the apparatus. When a cart is used, use caution when moving the cart/apparatus combination to avoid injury from tip-over.
- 13 Unplug this apparatus during lightning storms or when unused for long periods of time.
- 14 Refer all servicing to qualified service personnel. Servicing is required when the apparatus has been damaged in any way, such as power-supply cord or plug is damaged, liquid has been spilled or objects have fallen into the apparatus, the apparatus has been exposed to rain or moisture, does not operate normally, or has been dropped.



S3125A

- 15 The wall plug is the disconnecting device. The plug must remain readily operable.
- 16 Remote control batteries should not be exposed to excessive heat such as sunshine, fire, or the like.
- 17 The apparatus should not be exposed to dripping or splashing, and no objects filled with liquids, such as vases, should be placed on the apparatus.
- 18 Your TV has four VESA mounting holes on the back. If you attach a wall-mount bracket or TV stand to the back of your TV, **the bracket or stand must be securely attached using all four holes.** If you do not use all four mounting holes, your TV may fall and cause property damage or personal injury. See the documentation that came with your wall mount or TV stand for complete mounting instructions.

WARNING

Electric shock hazard

To reduce the risk of fire or electric shock, do not remove any cover or expose the device to rain or moisture. No user-serviceable parts are inside. Refer servicing to qualified service technicians.

Lightning

For added protection for your device receiver during a lightning storm, or when it is left unattended and unused for long periods of time, unplug it from the power outlet and disconnect any antenna or cable system. This helps prevent property damage and personal injury from lightning and power line surges.

Power lines

An outside antenna system should not be located in the vicinity of overhead power lines or other electric light or power circuits, or where it can fall into such power lines or circuits. When installing an outside antenna system, take extreme care to keep from touching such power lines or circuits as contact with them might be fatal.

Handling the LCD panel

- Your TV's screen is made of glass. Do not drop your TV or hit, jolt, or press hard against the LCD panel. If the screen breaks, be careful of broken glass.
- If the LCD panel is broken, make absolutely sure that you do not touch the liquid in the panel. This may cause skin inflammation.
- If the liquid gets in your mouth, immediately gargle, rinse, and consult with your doctor. Also, if the liquid gets in your eyes or touches your skin, consult with your doctor after rinsing for at least 15 minutes or longer in clean water.

Replacement parts

When replacement parts are required, make sure that the service technician uses replacement parts specified by the manufacturer that have the same characteristics as the original part. Unauthorized substitutions may result in fire, electric shock, personal injury, or other hazards.

Safety check

After completing any service or repair to this device, ask the service technician to perform routine safety checks to determine that your TV is in correct operating condition.

Power source

Operate your TV only from the type of power source indicated on the marking label. If you are not sure of the type of power supplied to your home, consult an electrician or your local power company.

Servicing

These servicing instructions are for use by qualified service personnel only. To reduce the risk of electric shock, do not perform any servicing other than that contained in the operating instructions unless you are qualified to do so.

CAUTION

Damage requiring service

Unplug this TV from the power outlet and refer servicing to qualified service personnel under the following conditions:

- When the power supply cord or plug is damaged or frayed.
- If liquid has been spilled or objects have fallen into your TV.
- If your TV has been exposed to rain or water.
- If your TV does not operate normally by following the operating instructions. Adjust only those controls covered by the operating instructions because incorrect adjustment of other controls may result in damage and will often require extensive work by a qualified technician to restore your TV to its normal operation.
- If your TV has been dropped or damaged in any way.
- When your TV exhibits a distinct change in performance.

Outdoor antenna grounding

If an outside antenna or cable system is connected to your TV, make sure that the antenna or cable system is grounded to provide some protection against voltage surges and built-up static charges. Article 810 of the National Electrical Code, ANSI/NFPA No. 70, provides information with respect to correct grounding of the mast and supporting structure, grounding of the lead-in wire to an antenna discharge unit, size of grounding conductors, location of the antenna-discharge unit, connection to grounding electrodes, and requirements for the grounding electrode.

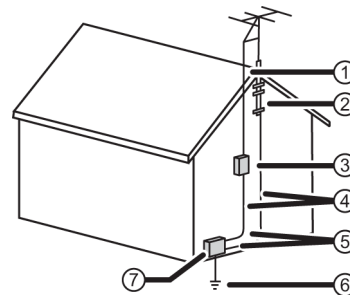

- ① Antenna lead-in wire
- ② Grounding clamp
- ③ Antenna discharge unit
- ④ Grounding conductors
- ⑤ Ground clamps
- ⑥ Power service grounding electrode system
- ⑦ Electric service equipment

Note to CATV system installer

Article 820 of the National Electrical Code, ANSI/NFPA No. 40 provides guidance for correct grounding. Specifically, it states that the cable ground must be connected to the grounding system of the building as close to the point of cable entry as practical.

Condensation

Moisture will form on the TV if the TV is brought from cool surroundings into a warm room or if the temperature of the room rises suddenly. When this happens, the TV's performance may be impaired. To prevent this, let the TV stand in its new surroundings for about an hour before switching it on, or make sure that the room temperature rises gradually.

Condensation may also form during the summer if the TV is exposed to the breeze from an air conditioner. In such cases, change the location of the TV.

Mobile telephone warning

To avoid interference with your TV picture and sound, operating problems, or even damage, keep your cordless and cellular telephones away from the TV.

End of life directives

Your TV may contain materials that are regulated for environmental reasons. Your TV also contains materials that can be recycled and reused. To help protect the environment, contact your local authorities for information about disposal or recycling and about finding a recycler in your area before you dispose of your TV.

Non-active pixels

The LCD panel contains almost 3 million thin film transistors, which provide exceptionally sharp video quality. Occasionally, a few non-active pixels may appear on the screen as a fixed blue, green, or red point. These non-active pixels do not adversely affect the performance of your TV, and are not considered defects.

Full HD LED 1080p TV

Introduction

Congratulations on your purchase of a high-quality Sharp product. Your LC-40LB480U represents the state of the art in LED TV design and is designed for reliable and trouble-free performance.

CEC Control

Enjoy the benefit of having HDMI CEC compatible products plug and play! No setup is needed! CEC technology lets different components discover and communicate with each other. (See page [35](#) for instructions on how to use CEC Control.)

DTS TruSurround™

DTS TruSurround delivers clear, crisp, and natural sound while providing deep enveloping bass.

Game mode

Video games generally require adjustments to the television picture settings to get the maximum experience. By simply pressing a button on your remote control, your television settings will automatically adjust for video games. It couldn't be easier. (See the **Game** option in "[Adjusting the TV picture](#)" on page [40](#) for instruction on how to select Game mode.)

Installing the stands or wall-mount bracket

Notes

- If you plan to wall-mount your TV, do not install the stands.
- Store the stands and stand screws in case you decide to use the stands in the future.

Installing the stands

- 1 Carefully place your TV face-down on a cushioned, clean surface to protect the screen from damages and scratches.

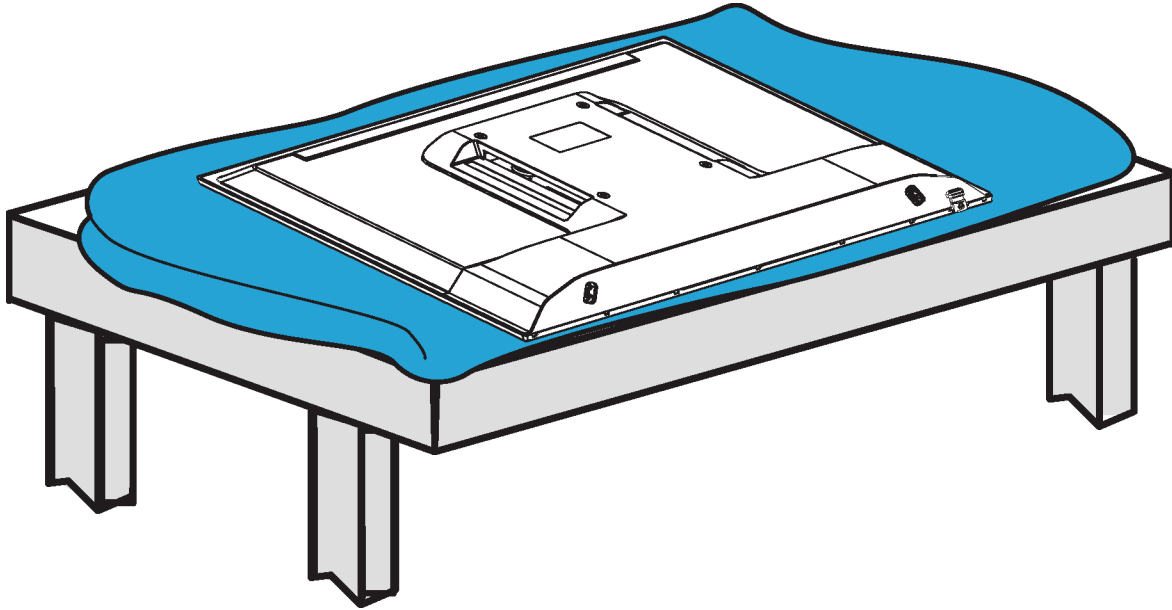

- 2 Align the TV stands with the screw holes on the bottom of your TV, then secure the stands to the TV with the four provided screws.

Screw type	Screw length	# of screws
M4	20 mm	4

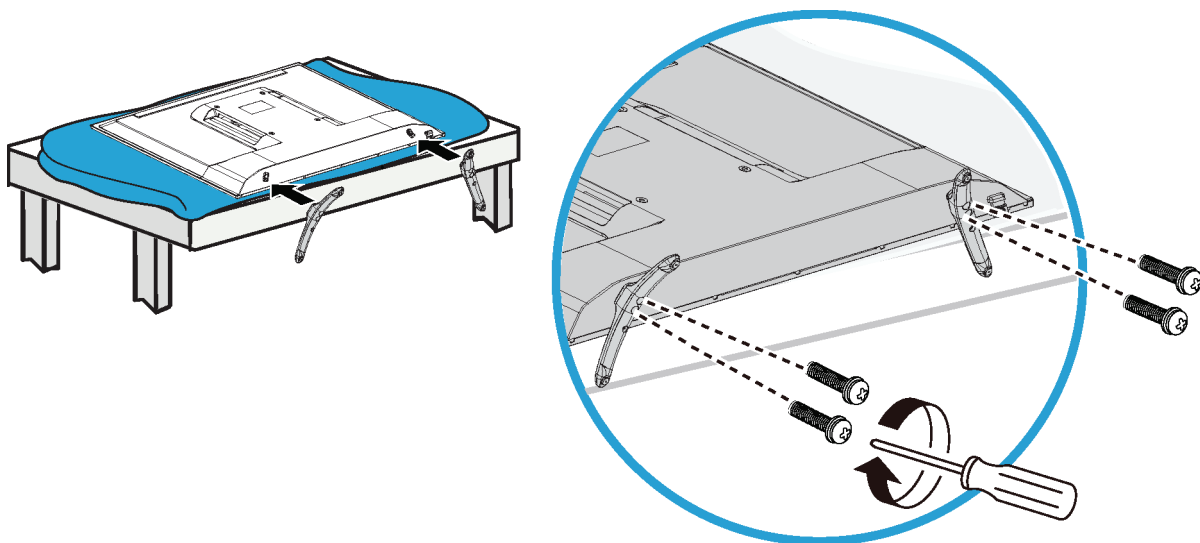

Installing a wall-mount bracket

Warning

- Your TV has four VESA mounting holes on the back. If you attach a wall-mount bracket to the back of your TV, **the bracket must be securely attached, using all four holes.** If you do not use all four mounting holes, your TV may fall and cause property damage or personal injury. See the documentation that came with your wall mount for complete mounting instructions.
- This TV is intended to be supported by a UL Listed wall mount bracket with suitable weight/load. (See “Miscellaneous” on page 67.)
- To prevent injury, this apparatus must be securely attached to the floor/wall in accordance with the installation instructions.

- 1 Carefully place your TV face-down on a cushioned, clean surface to protect the screen from damages and scratches.

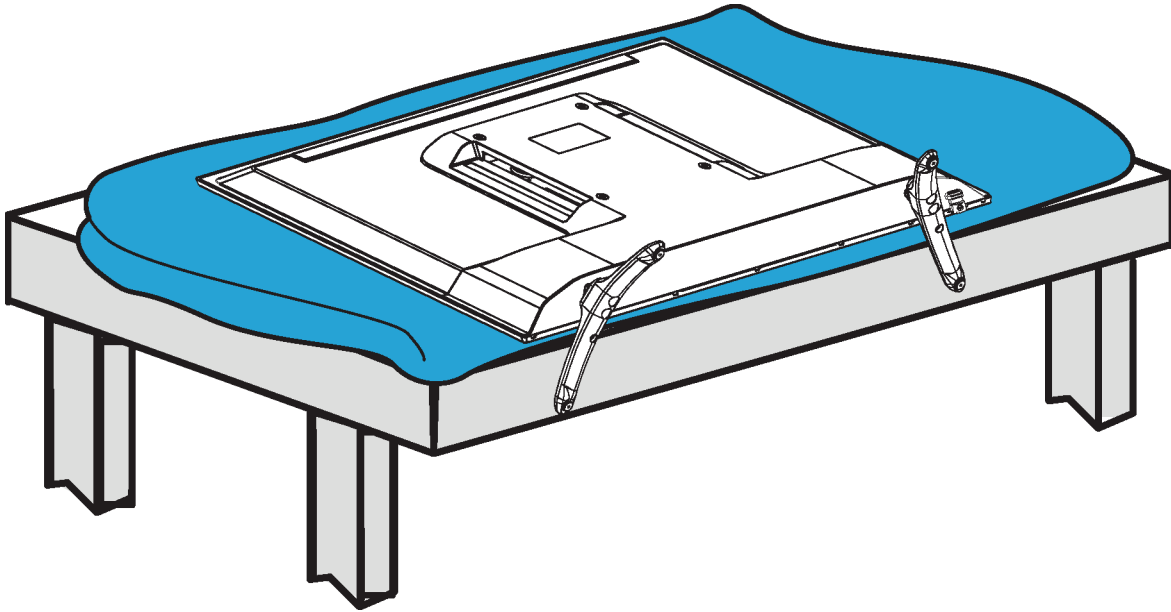

2 If the TV stands are attached, remove the four screws that secure the stands to your TV.

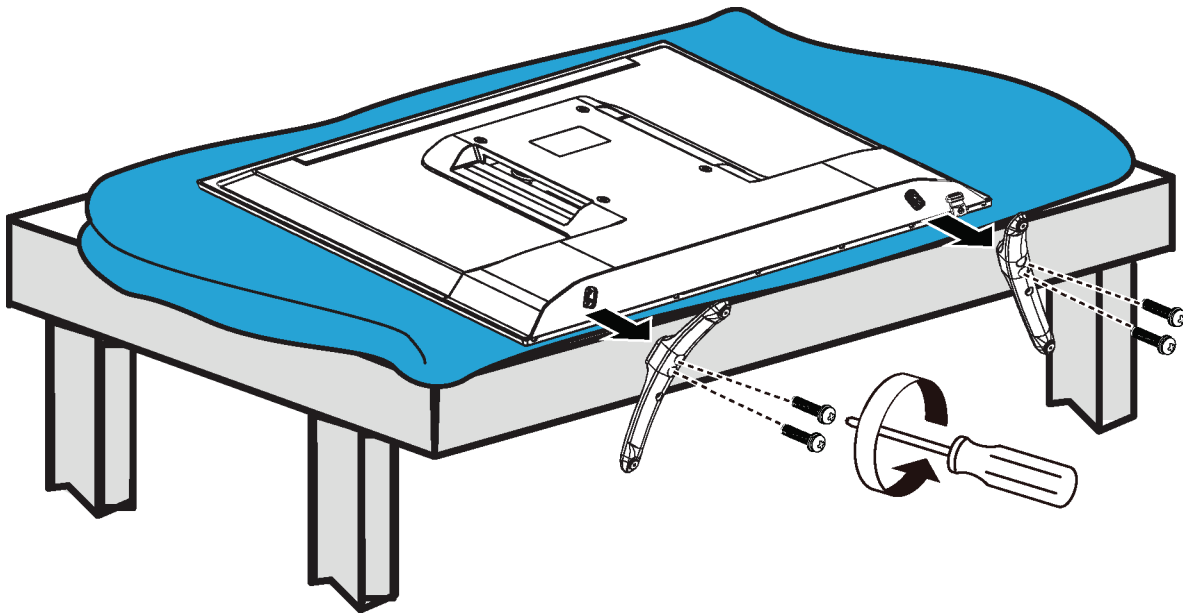

Notes

- The length of the wall-mount screws vary depending on the wall-mount bracket you purchased. See the instructions that came with the wall-mount bracket for screw lengths.
- The mounting holes on the back of your TV take type M6 screws.

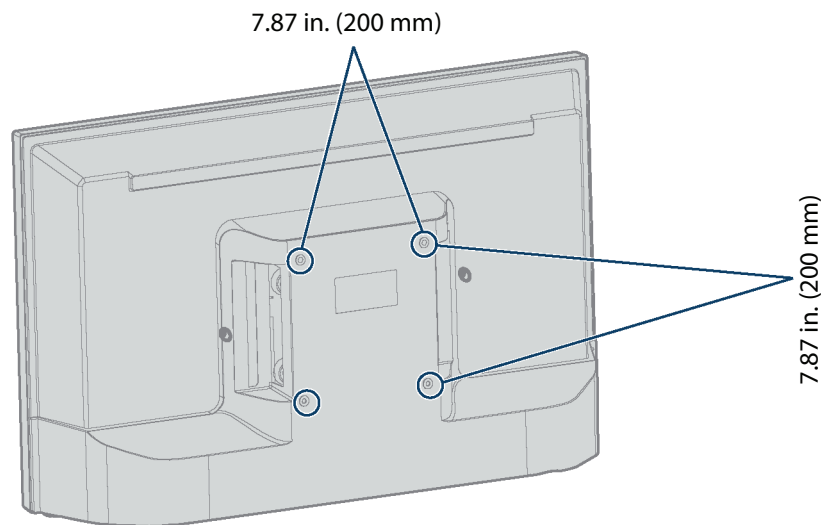

TV components

Package contents

- 40" LED TV
- Remote control and batteries (2 AAA)
- TV stands (2) and screws (4)
- Power cord
- *Quick Setup Guide*
- *Important Information*

Front

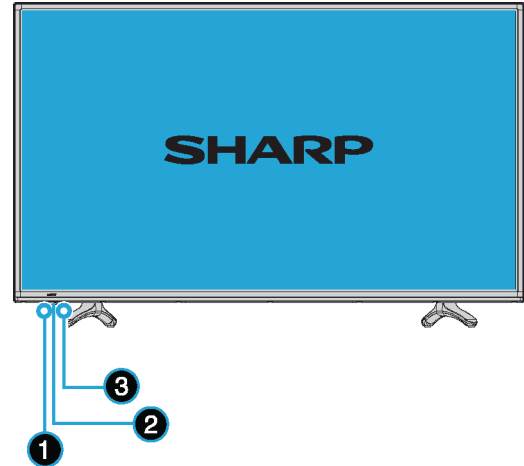

#	Item	Description
1	Remote control sensor	Receives signals from the remote control. Do not block.
2	⏻/INPUT	<p>⏻—Press to turn on your TV when your TV is off (in standby mode). Press and hold to turn off your TV when your TV is on.</p> <p>Warning: When your TV is off, power still flows through it. To completely disconnect power, unplug the power cord.</p> <p>INPUT—When your TV is on, quickly press and release to open the <i>INPUT SOURCE</i> list, press one or more times to select a video input source, then wait a few seconds. Your TV switches to the source you selected. For more information, see “Selecting the video input source” on page 32.</p>
3	Power indicator	Turns off when your TV is on. Lights red when your TV is off (standby mode).

Left side

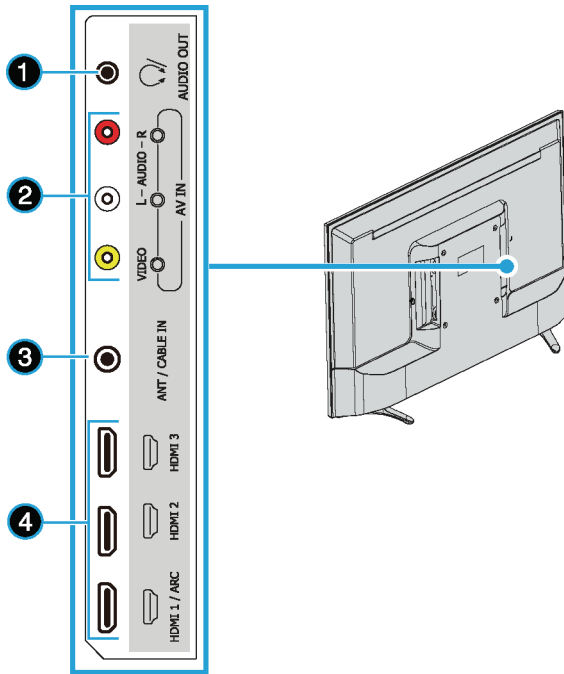

#	Item	Description
1	🎧/AUDIO OUT	Connect headphones, an analog audio amplifier, a home theater system, or a sound bar to this jack. For more information, see "Connecting headphones" on page 23 or "Analog audio" on page 25.
2	VIDEO and L/R (audio)	Connect the video and audio for an AV device to these jacks. For more information, see "AV (good)" on page 14, 18, or 20.
3	ANT / CABLE IN	Connect an antenna or cable TV to this jack. For more information, see "Coaxial (good)" on page 15 or "Connecting an antenna or cable TV (no box)" on page 16.
4	HDMI 3/HDMI 2/ HDMI 1/ARC	Connect HDMI devices to these jacks. For more information, see "HDMI (best)" on pages 13, 17, 19, or 21. OR Connect a home theater that supports ARC to the HDMI 1/ARC jack.

Right side

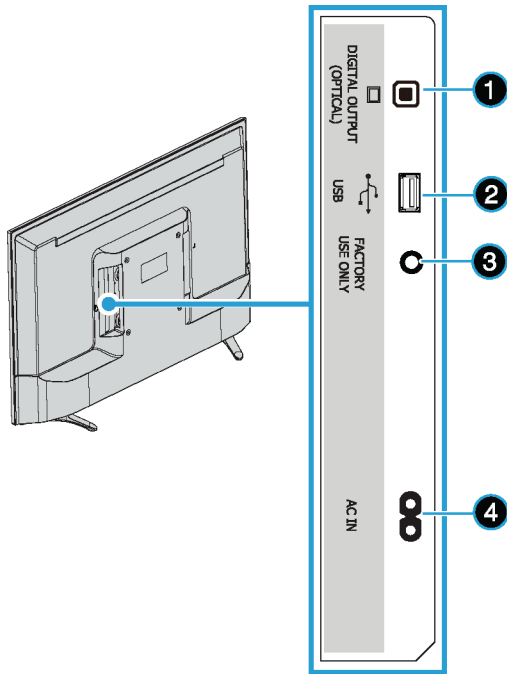

#	Item	Description
1	DIGITAL OUTPUT (OPTICAL)	Connect a digital audio amplifier, home theater system, or sound bar to this jack to listen to TV audio through the external speakers. For more information, see "Digital audio" on page 24.
2	USB	Connect a USB flash drive to this jack to view compatible JPEG picture files. For more information, see "Connecting a USB flash drive" on page 22 and "Using a USB flash drive" on page 38.
3	FACTORY USE ONLY	Do not connect a device to this jack.
4	AC IN	Plug the power cord into this connector and into a power outlet.

Remote control

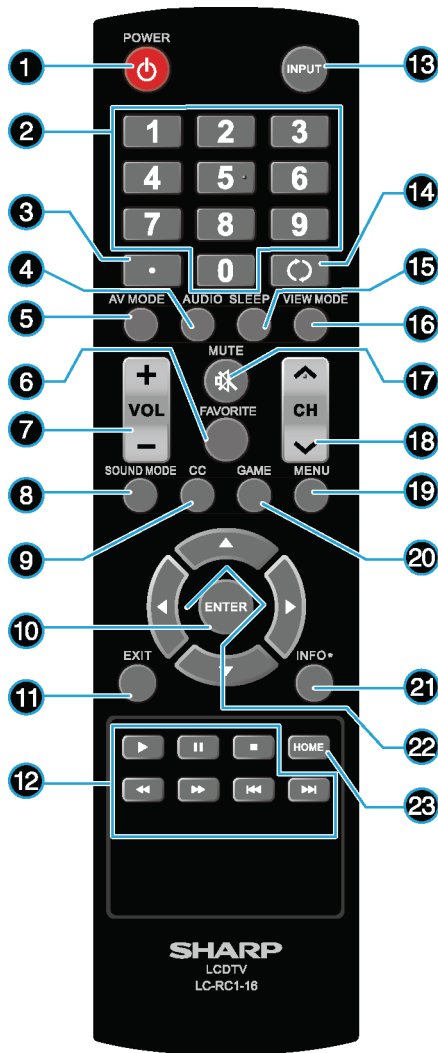

#	Button	Press to...
6	FAVORITE	Open the <i>FAVORITES LIST</i> . See “ Setting up a favorite channel list ” on page 46 and “ Viewing a favorite channel ” on page 47.
7	VOL+/-	Increase or decrease the volume.
8	SOUND MODE	Select the sound mode. You can select Standard , Movie , Music , Voice , or User . See the Sound Mode option in “ Adjusting sound settings ” on page 43.
9	CC	Turn closed captioning on or off. You can select Off , On Always , or On When Mute . See “ Turning closed captioning on or off ” on page 53.
10	ENTER	Confirm selections or changes or to open sub-menus.
11	EXIT	Close the on-screen menu.
12	Media controls	Control CEC devices connected to your TV. See “ Using CEC Control ” on page 35.
13	INPUT	Open the <i>INPUT SOURCE</i> list, press ▲ or ▼ on the remote control to select the video input source, then press ENTER . See “ Selecting the video input source ” on page 32.
14	↺	Return to the previous channel.
15	SLEEP	Set the sleep timer. You can select Off , 5 , 10 , 15 , 30 , 60 , 90 , 120 , 180 , or 240 minutes. See “ Setting the sleep timer ” on page 57.
16	VIEW MODE	Change how the picture looks on the screen (aspect ratio). See the Aspect ratio option in “ Adjusting the TV picture ” on page 40.
17	MUTE	Press to mute or un-mute the sound.
18	CH ▲/CH ▼	Change TV channels. For more information, see “ Selecting a channel ” on page 34.
19	MENU	Open the on-screen menu.
20	GAME	Changes the picture mode to Game mode. For more information, see the Game option in Adjusting the TV picture on page 40.
21	INFO*	Display TV status information, such as the channel number, channel name (if available), or signal source. See “ Viewing channel information ” on page 34.
22	▲ ▼ ◀ ▶	Navigate in on-screen menus and to adjust settings.
23	HOME	Open the on-screen menu.





#	Button	Press to...
1	POWER	Turn your TV on or off (standby mode). Warning: When your TV is off, power still flows through it. To disconnect power, unplug the power cord.
2	Numbers	Enter channel numbers and the parental control password.
3	●	Enter a digital sub-channel number. See “ Selecting a channel ” on page 34.
4	AUDIO	Select the audio mode for an analog program. You can select: <ul style="list-style-type: none"> • Mono—Select this option if there is noise or static on weak stereo broadcasts. • Stereo—Select this option for programs broadcast in stereo. • SAP—Select this option to listen to a secondary audio program, if available. OR Select the audio language for a digital program, if alternate languages are available.
5	AV MODE	Select the AV (picture) mode. You can select Standard , Movie , Game , User , Dynamic , or Natural . See the AV Mode option in “ Adjusting the TV picture ” on page 40.

What connection should I use?

Your TV has several connection types for connecting devices to your TV.

For the best video quality, you should connect a device to the best available connection.

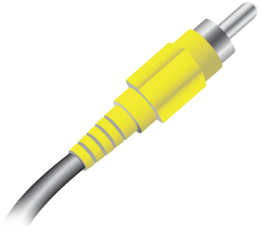
Use the following tables to identify cables:

Video quality	Connection type and jack	Cable connector
Best (use this if your devices have HDMI)	HDMI video/audio 	
Better than coaxial	AV (requires an audio connection) 	
Good	Coaxial video/audio 	

Connection type and jack

Cable connectors

Optical digital output audio



Analog audio input

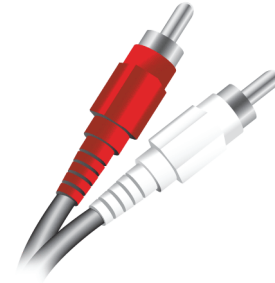

Analog audio output



Cautions

- Check the jacks for position and type before making any connections.
- Loose connections can cause poor audio or video quality. Make sure that all connections are tight and secure.
- The external audio/video equipment shown may be different from your equipment. If you have questions, refer to the documentation that came with your equipment.
- Always unplug the power cord when connecting external equipment.

Connecting a cable or satellite box

Many cable or satellite TV boxes have more than one connection type. To get the best video, you should use the best connection type available. For more information, see [“What connection should I use?”](#) on page 12.

HDMI (best)

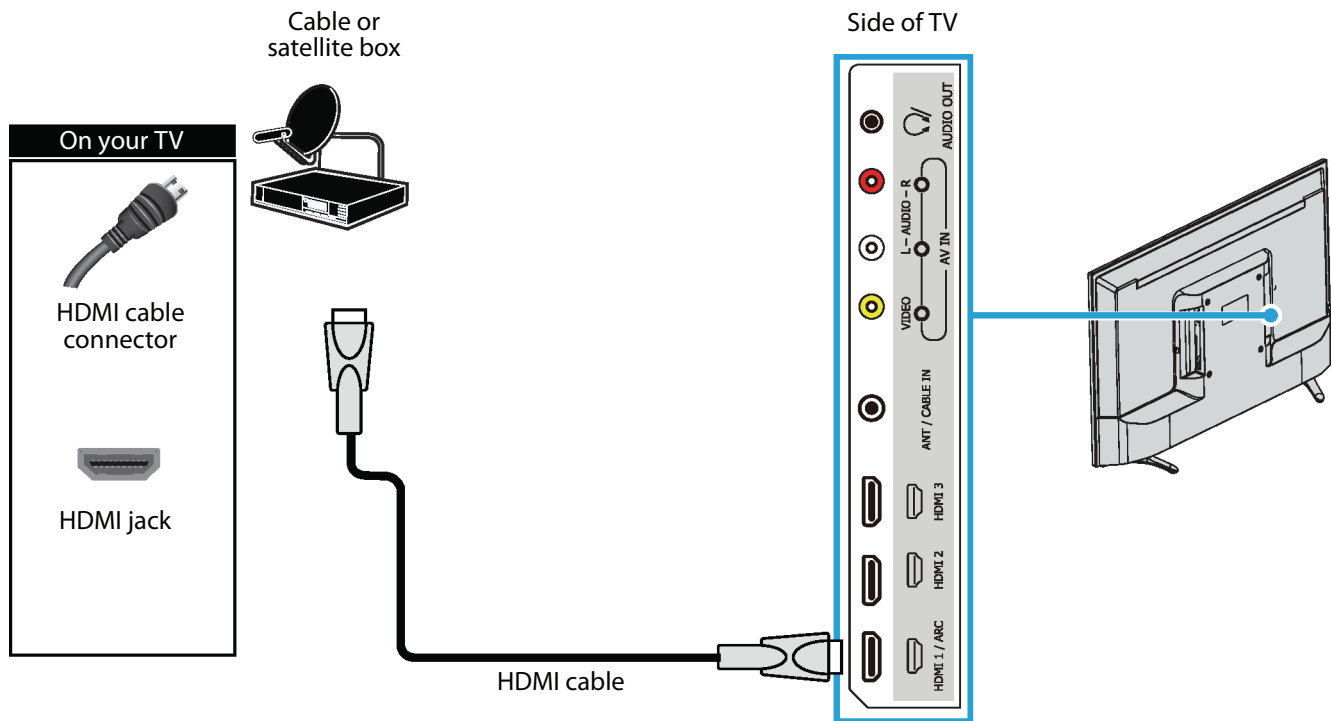

- 1 Make sure that your TV's power cord is unplugged and all connected equipment is turned off.
- 2 Connect the incoming cable from the cable wall jack to the cable-in jack on the cable or satellite box.
- 3 Connect an HDMI cable (not provided) to one of the **HDMI** jacks on your TV and to the **HDMI OUT** jack on the cable or satellite box.
- 4 Plug your TV's power cord into a power outlet, turn on your TV, then turn on the cable or satellite box.
- 5 Press **INPUT** to open the *INPUT SOURCE* list.
- 6 Press **▲** or **▼** to highlight **HDMI 1**, **HDMI 2**, or **HDMI 3**, then press **ENTER**.

Note

An HDMI cable carries both audio and video. You do not need to use any audio cables.

AV (good)

Notes
Cables are often color-coded to match color-coded jacks.

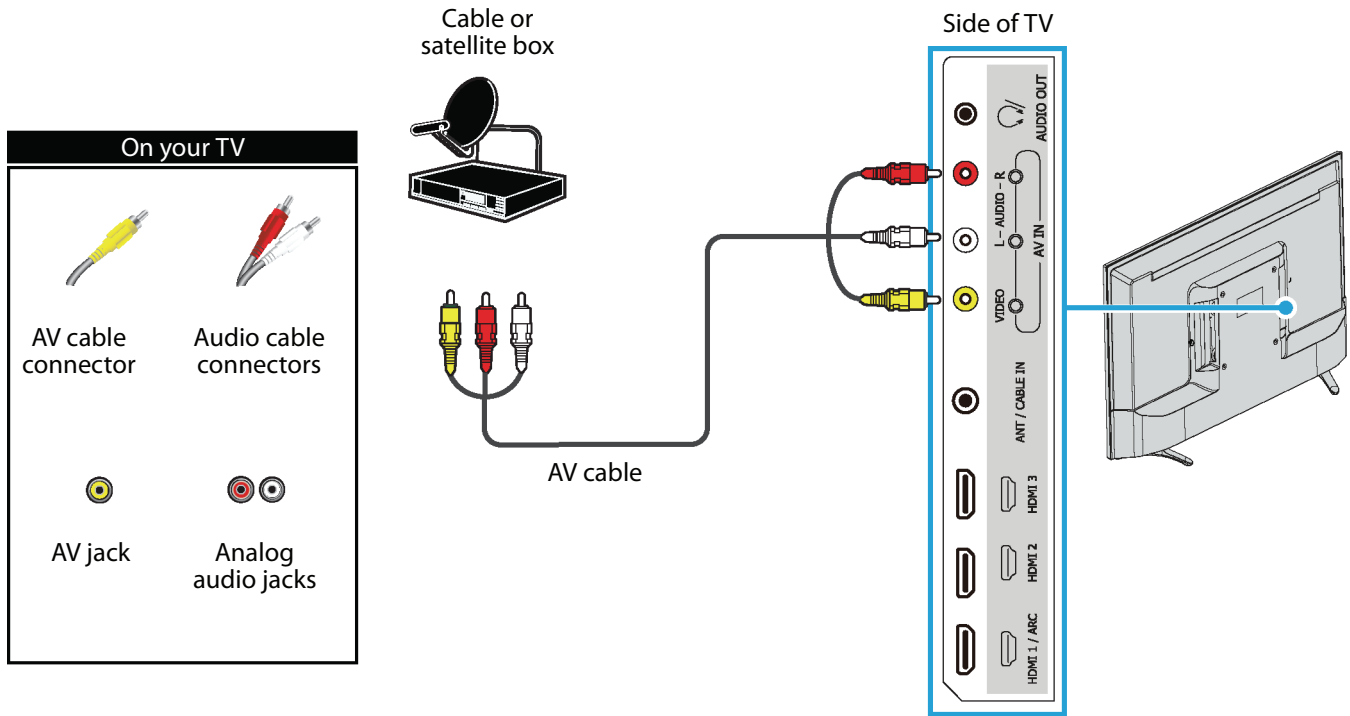

- 1 Make sure that your TV's power cord is unplugged and all connected equipment is turned off.
- 2 Connect the incoming cable from the cable wall jack to the cable-in jack on the cable or satellite box.
- 3 Connect an AV cable (not provided) to the **VIDEO** jack and **L** and **R AUDIO** jacks on your TV and to the AV and audio out jacks on the cable or satellite box.

Important
When you connect the audio using the **L** and **R AUDIO** jacks, the audio output is analog.

- 4 Plug your TV's power cord into a power outlet, turn on your TV, then turn on the cable or satellite box.
- 5 Press **INPUT** to open the *INPUT SOURCE* list.
- 6 Press **▲** or **▼** to select **AV**, then press **ENTER**.

Coaxial (good)

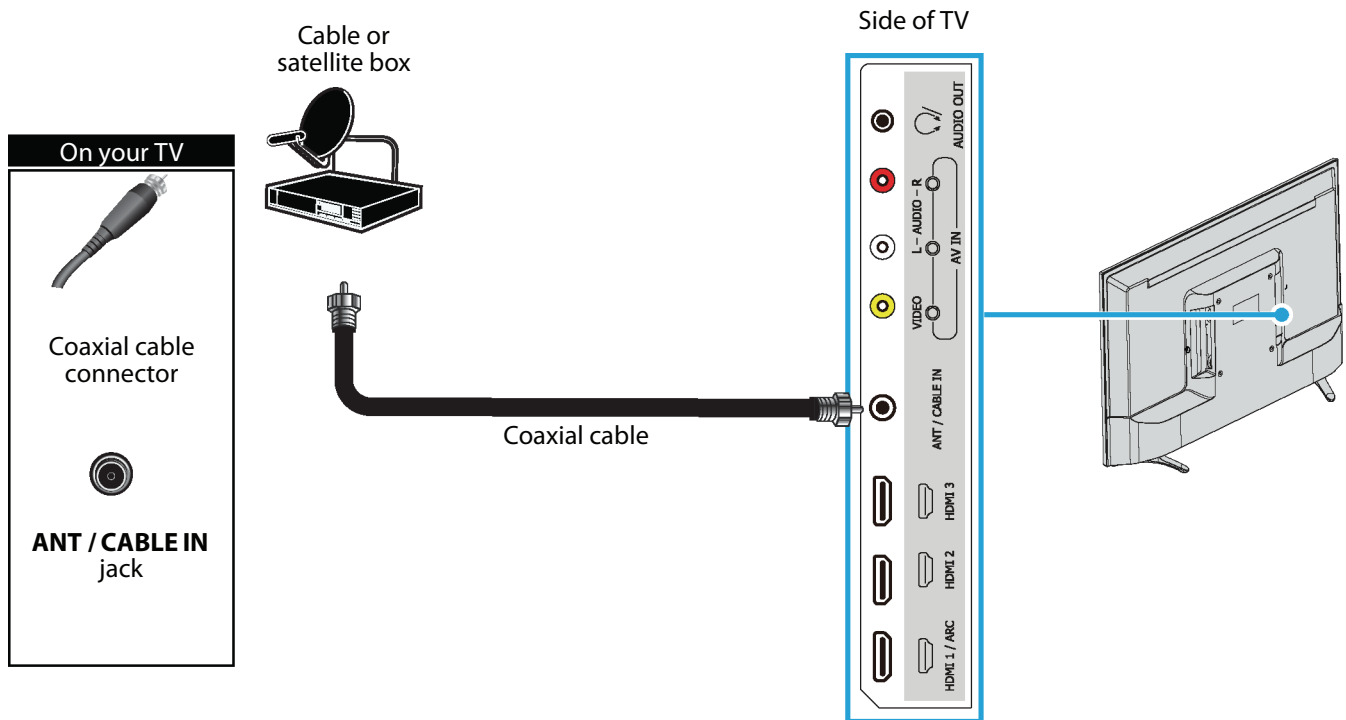

- 1 Make sure that your TV's power cord is unplugged and all connected equipment is turned off.
- 2 Connect the incoming cable from the cable wall jack to the cable-in jack on the cable or satellite box.
- 3 Connect a coaxial cable (not provided) to the **ANT / CABLE IN** jack on your TV and to the coaxial out jack on the cable or satellite box.
- 4 Plug your TV's power cord into a power outlet, turn on your TV, then turn on the cable or satellite box.
- 5 Press **INPUT** to open the *INPUT SOURCE* list.
- 6 Press **▲** or **▼** to highlight **TV**, then press **ENTER**.
- 7 If you cannot tune to channels you know exist, scan for channels. See "[Automatically scanning for channels](#)" on page 45.

Notes

- Use a coaxial cable to eliminate interference and noise from radio waves.
- Do not bundle the coaxial cable with the power cord or other cables.

Connecting an antenna or cable TV (no box)

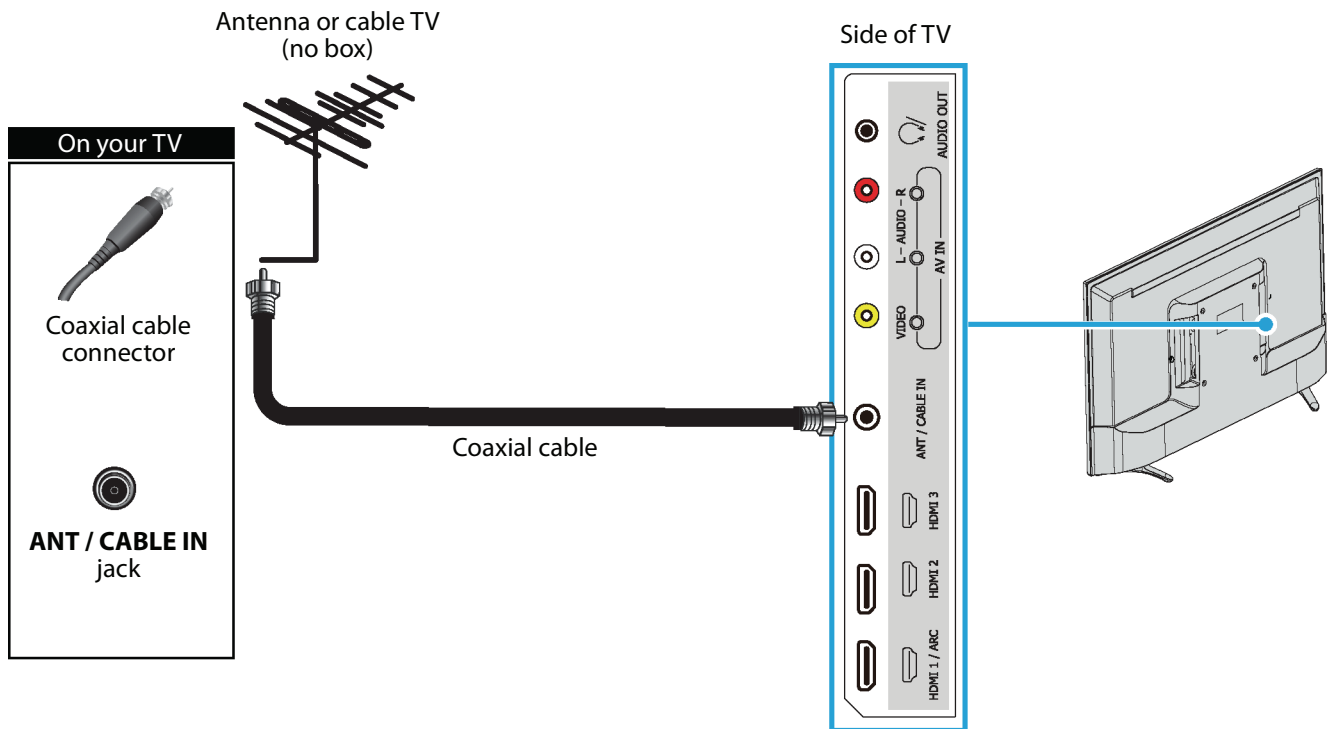

- 1 Make sure that your TV's power cord is unplugged and all connected equipment is turned off.
- 2 Connect a coaxial cable (not provided) to the **ANT / CABLE IN** jack on your TV and to the antenna or cable TV wall jack.
- 3 Plug your TV's power cord into a power outlet, then turn on your TV.
- 4 Press **INPUT** to open the *INPUT SOURCE* list.
- 5 Press **▲** or **▼** to highlight **TV**, then press **ENTER**.
- 6 If you cannot tune to channels you know exist, scan for channels. See "[Automatically scanning for channels](#)" on page 45.

Notes

- Use a coaxial cable to eliminate interference and noise from radio waves.
- Do not bundle the coaxial cable with the power cord or other cables.
- If the antenna is not installed correctly, contact qualified service personnel to correct the problem.
- If the signal level for a channel is weak, the picture may be distorted. Adjust the antenna or use a highly directional outdoor or set-top antenna with a built-in amplifier.
- If the picture quality is good on some channels and poor on others, the problem may be caused by a poor or weak signal from the broadcaster or cable TV provider.
- If you connect to cable or satellite TV without a set-top box and experience poor picture quality, you may need to install a set-top box to improve signal reception and picture quality. Contact your cable or satellite TV provider about upgrading to a set-top box.
- Many high-definition (HD) channels upscale standard-definition (SD) content. The picture displayed on your TV is still displayed as SD, thus the picture quality will not be as clear or crisp as it would be if the content was originally recorded in HD.

Connecting a DVD or Blu-ray player

Many DVD or Blu-ray players have more than one connection type. To get the best video, you should use the best connection type available. For more information, see [“What connection should I use?”](#) on page 12.

HDMI (best)

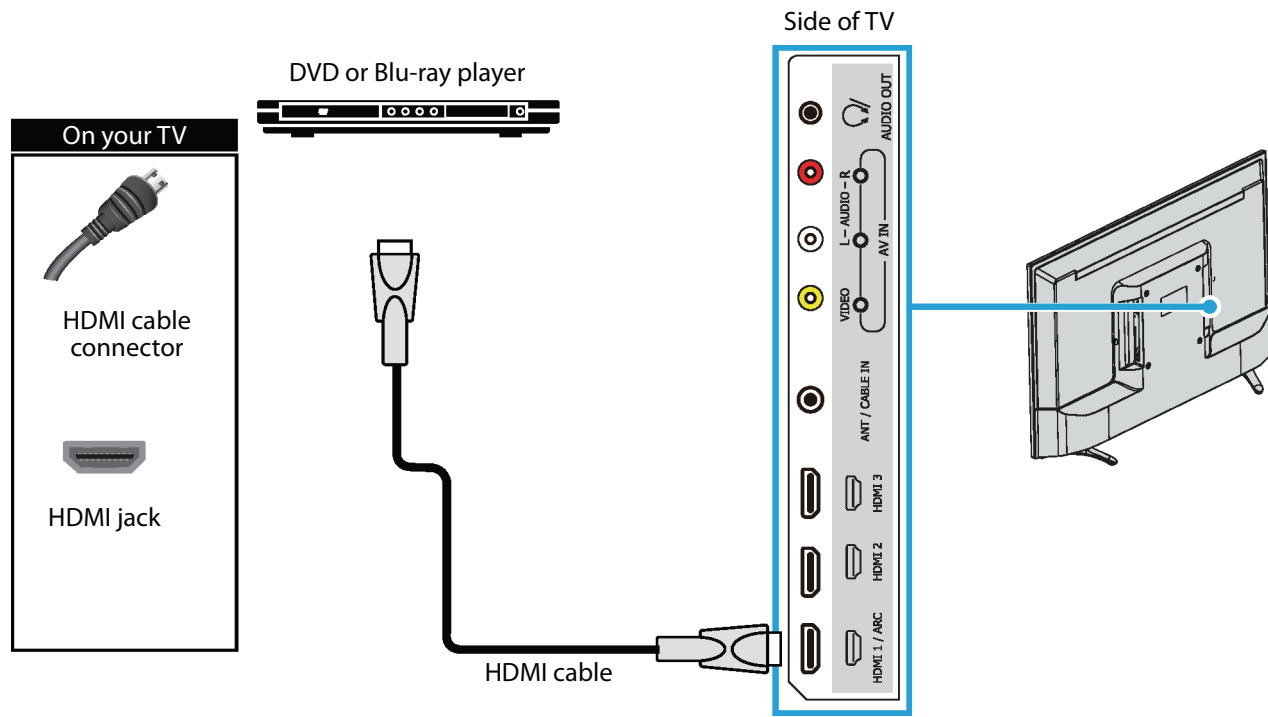

- 1 Make sure that your TV's power cord is unplugged and the DVD or Blu-ray player is turned off.
- 2 Connect an HDMI cable (not provided) to one of the **HDMI** jacks on your TV and to the **HDMI OUT** jack on the DVD or Blu-ray player.
- 3 Plug your TV's power cord into a power outlet, then turn on your TV and the DVD or Blu-ray player.
- 4 Press **INPUT** to open the *INPUT SOURCE* list.
- 5 Press **▲** or **▼** to highlight **HDMI 1**, **HDMI 2**, or **HDMI 3**, then press **ENTER**.

Note

An HDMI cable carries both audio and video. You do not need to use any audio cables.

AV (good)

Notes

Cables are often color-coded to match color-coded jacks.

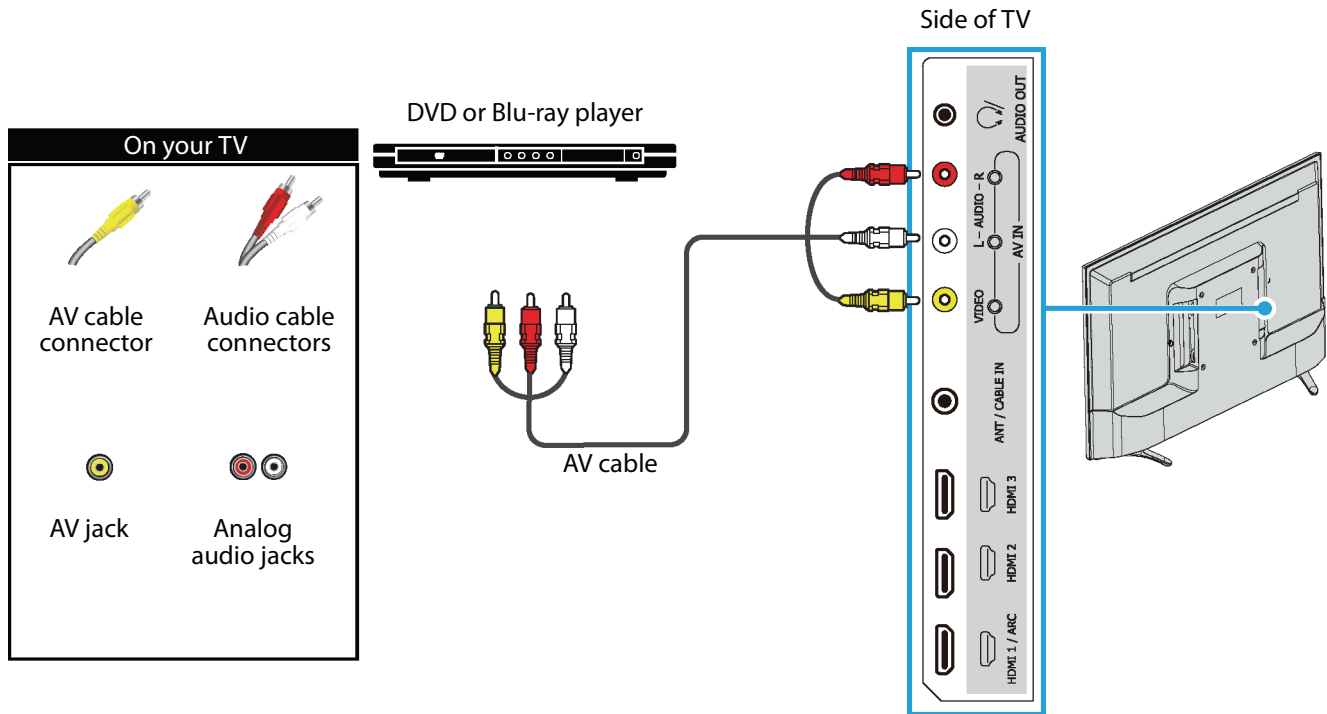

- 1 Make sure that your TV's power cord is unplugged and the DVD or Blu-ray player is turned off.
- 2 Connect an AV cable (not provided) to the **VIDEO** jack and **L** and **R AUDIO** jacks on your TV and to the **AV OUT** jacks on the DVD or Blu-ray player.

Important

When you connect the audio using the **L** and **R AUDIO** jacks, the audio output is analog.

- 3 Plug your TV's power cord into a power outlet, then turn on your TV and the DVD or Blu-ray player.
- 4 Press **INPUT** to open the *INPUT SOURCE* list.
- 5 Press **▲** or **▼** to select **AV**, then press **ENTER**.

Connecting a game console

HDMI (best)

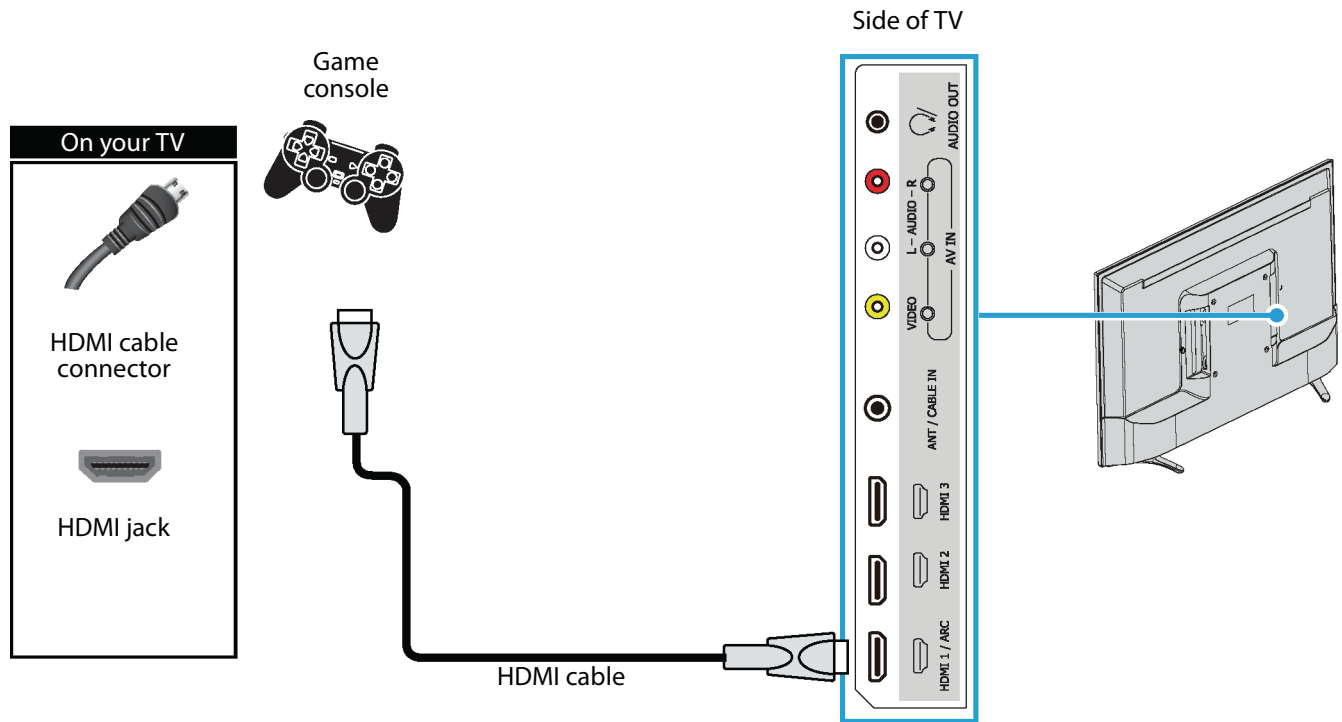

- 1 Make sure that your TV's power cord is unplugged and the game console is turned off.
- 2 Connect an HDMI cable (not provided) to one of the **HDMI** jacks on your TV and to the **HDMI OUT** jack on the game console.
- 3 Plug your TV's power cord into a power outlet, then turn on your TV.
- 4 Turn on the game console, then set it to the correct output mode. For more information, see the documentation that came with the console.
- 5 Press **INPUT** to open the *INPUT SOURCE* list.
- 6 Press **▲** or **▼** to highlight **HDMI 1**, **HDMI 2**, or **HDMI 3**, then press **ENTER**.

Note

An HDMI cable carries both audio and video. You do not need to use any audio cables.

AV (good)

Notes

Cables are often color-coded to match color-coded jacks.

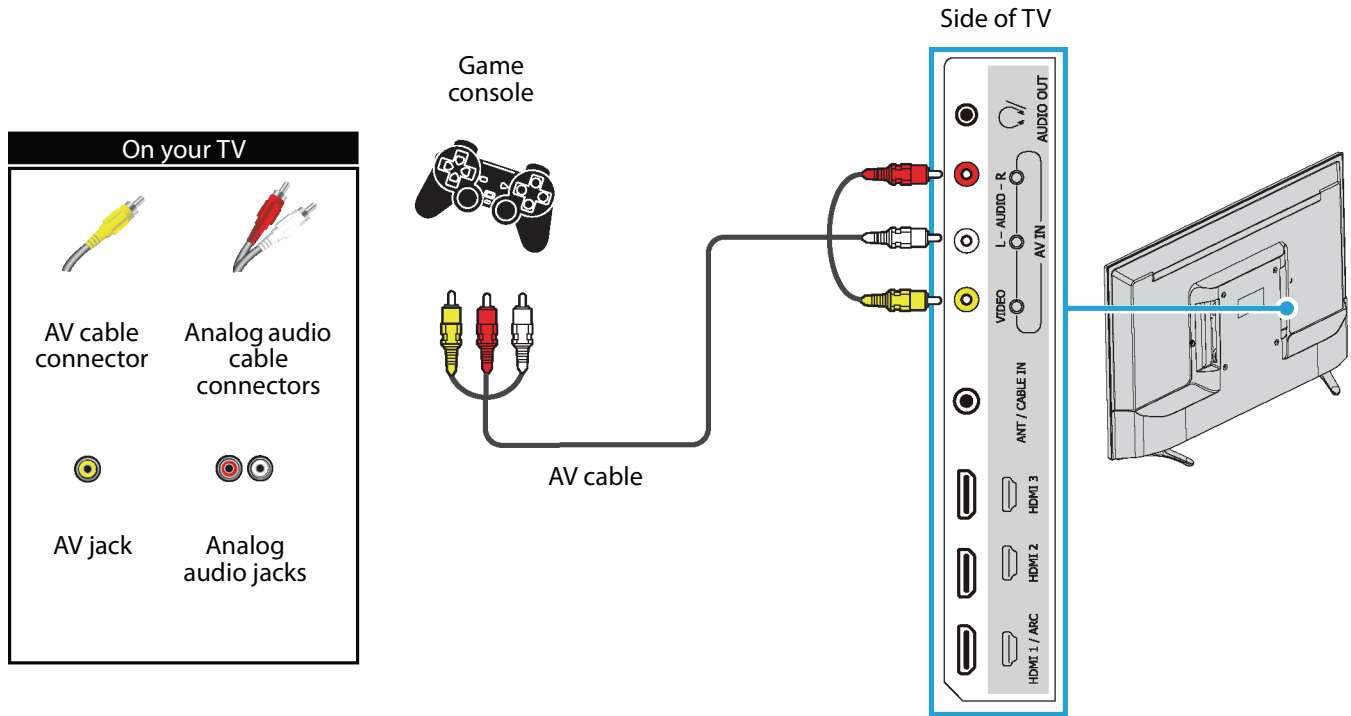

- 1 Make sure that your TV's power cord is unplugged and the game console is turned off.
- 2 Connect the video and audio connectors on the game console's AV cable (not provided) to the **VIDEO** jack and **L** and **R AUDIO** jacks on your TV and to the composite jack(s) on the game console.

Important

- Some older game consoles come with a special AV cable. See the documentation that came with your game console or check the manufacturer's website.
- When you connect the audio using the **L** and **R AUDIO** jacks, the audio output is analog.

- 3 Plug your TV's power cord into a power outlet, then turn on your TV.
- 4 Turn on the game console, then set it to the correct output mode. For more information, see the documentation that came with the console.
- 5 Press **INPUT** to open the *INPUT SOURCE* list.
- 6 Press **▲** or **▼** to select **AV**, then press **ENTER**.

Connecting a computer

HDMI (best)

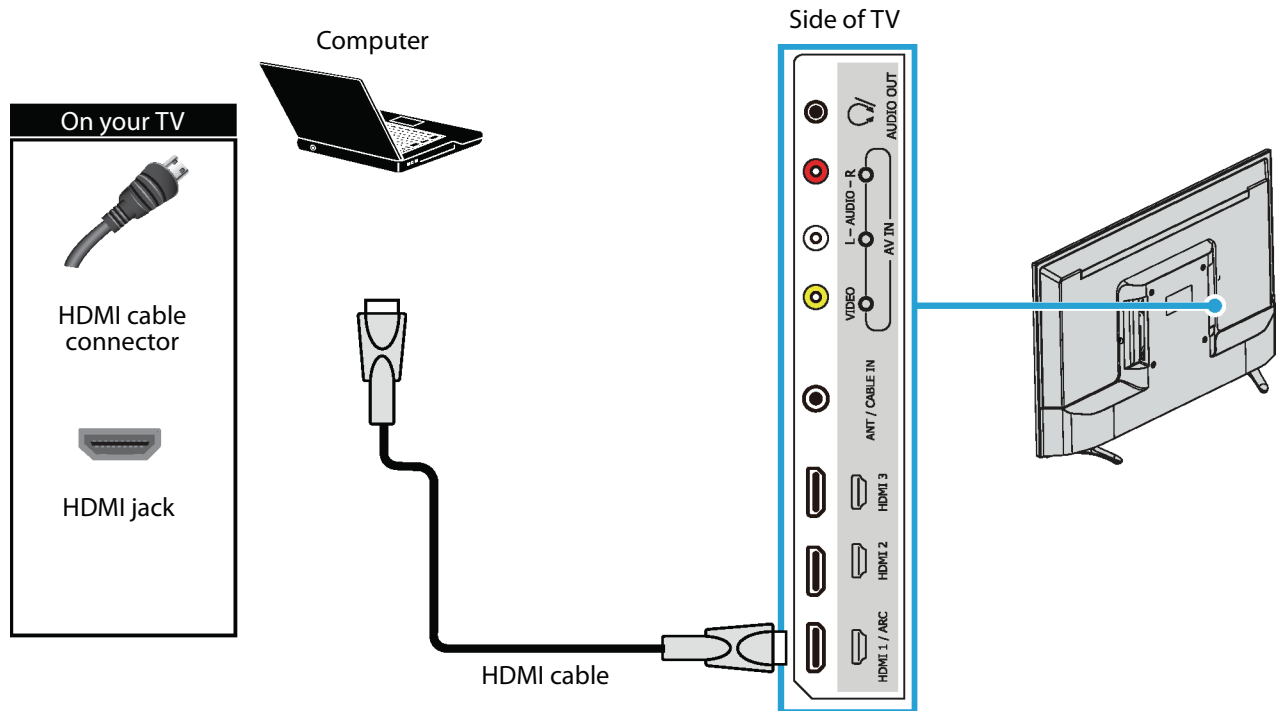

- 1 Make sure that your TV's power cord is unplugged and the computer is turned off.
- 2 Connect an HDMI cable (not provided) to one of the **HDMI** jacks on your TV and to the **HDMI OUT** jack on the computer.
- 3 Plug your TV's power cord into a power outlet, then turn on your TV and the computer.
- 4 Press **INPUT** to open the *INPUT SOURCE* list.
- 5 Press **▲** or **▼** to highlight **HDMI 1**, **HDMI 2**, or **HDMI 3**, then press **ENTER**.
- 6 Adjust the display properties on the computer, if necessary.

Connecting a USB flash drive

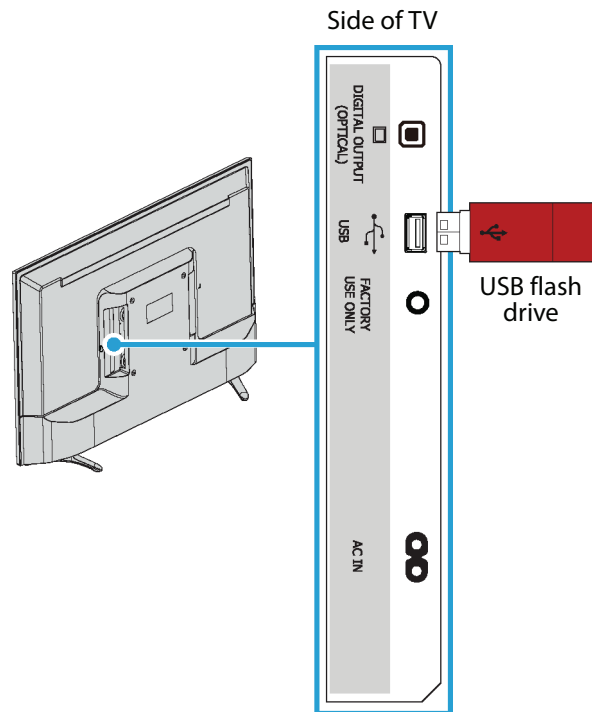

- 1 Plug a USB flash drive into the **USB** port on your TV.

Caution

Do not remove the USB flash drive or turn off the TV while using the USB flash drive. You may lose data or damage the USB flash drive.

- 2 If your TV is turned on when you connect the USB flash drive, press **▲** or **▼** to select **Yes** in the message that appears, then press **ENTER**. The *PHOTOS* menu opens.

OR

If you switch to a different video input source after you plug in the USB flash drive and want to switch back to the drive, press **INPUT** to open the *INPUT SOURCE* list, press **▲** or **▼** to select **USB (Photos)**, then press **ENTER**. The *PHOTOS* menu opens.

Note

The **PHOTOS** viewer only supports JPEG format images (with ".jpg" file extensions) and not all JPEG files are compatible with your TV. For more information, see "[Using a USB flash drive](#)" on page 38.

Connecting headphones

When you connect headphones, the TV speakers are muted.

Warning

Loud noise can damage your hearing. When using headphones, use the lowest volume setting on your headphones that still lets you hear the sound.

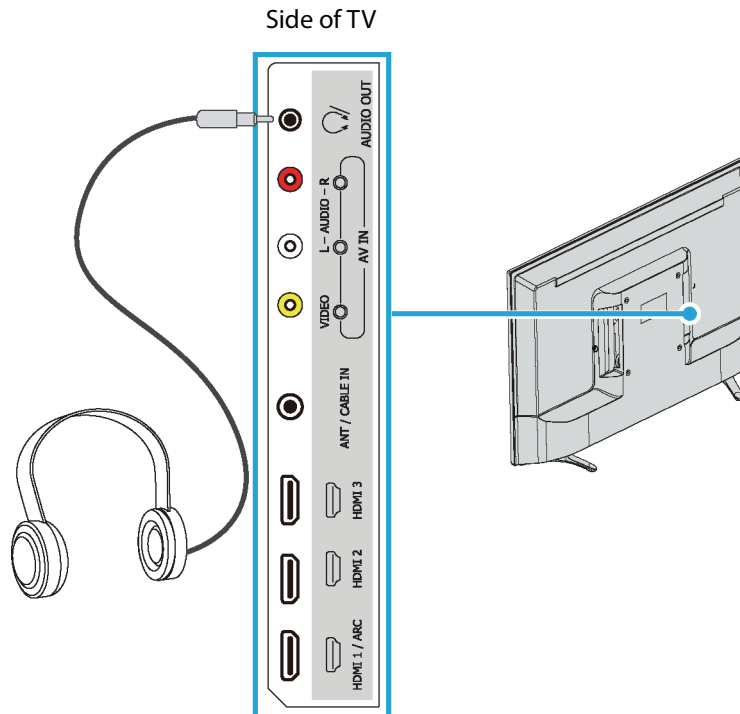

- 1 Connect the headphones to the /AUDIO OUT jack on your TV.
- 2 In the screen that opens, press ◀ or ▶ to highlight **Headphones/Audio Out**, then press **ENTER**. For more information, see "[Selecting the audio out mode](#)" on page 44.

Notes

- If you connect headphones when your TV is turned off, then you turn on your TV, the TV speakers are muted and the audio plays through the headphones.
- You can also connect an amplifier, home theater system, or sound bar to the /AUDIO OUT jack. If you want to connect an amplifier, home theater system, or sound bar, you need to disconnect the headphones.

Connecting external speakers or a sound bar

You can connect external speakers or a sound bar to the digital audio jack.

Digital audio

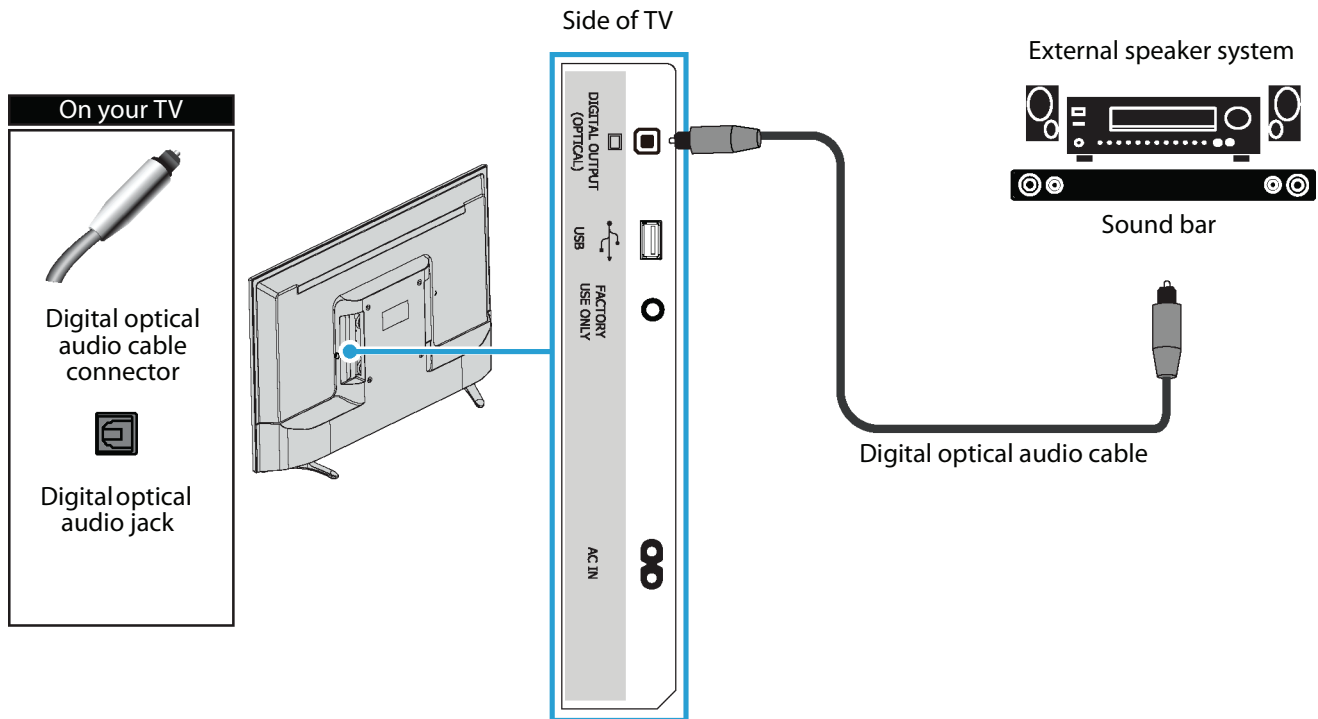

- 1 Make sure that your TV's power cord is unplugged and the external speaker system or sound bar is turned off.
- 2 Connect a digital optical audio cable (not provided) to the **DIGITAL OUTPUT (OPTICAL)** jack on your TV and to the optical **AUDIO IN** jack on the external speaker system or sound bar.
- 3 Plug your TV's power cord into a power outlet, then turn on your TV.
- 4 Turn on the external speaker system or sound bar, then set it to the correct source. For more information, see the documentation that came with the external speaker system or sound bar.
- 5 On your TV, highlight the **Digital Audio Format/Audio Delay** option on the *Sound* menu, then press **ENTER**. Set the **Audio Format** option to **PCM**. See "[Adjusting sound settings](#)" on page 43.

Analog audio

When you connect external speakers or a sound bar to the  **AUDIO OUT** jack, the TV speakers are muted.

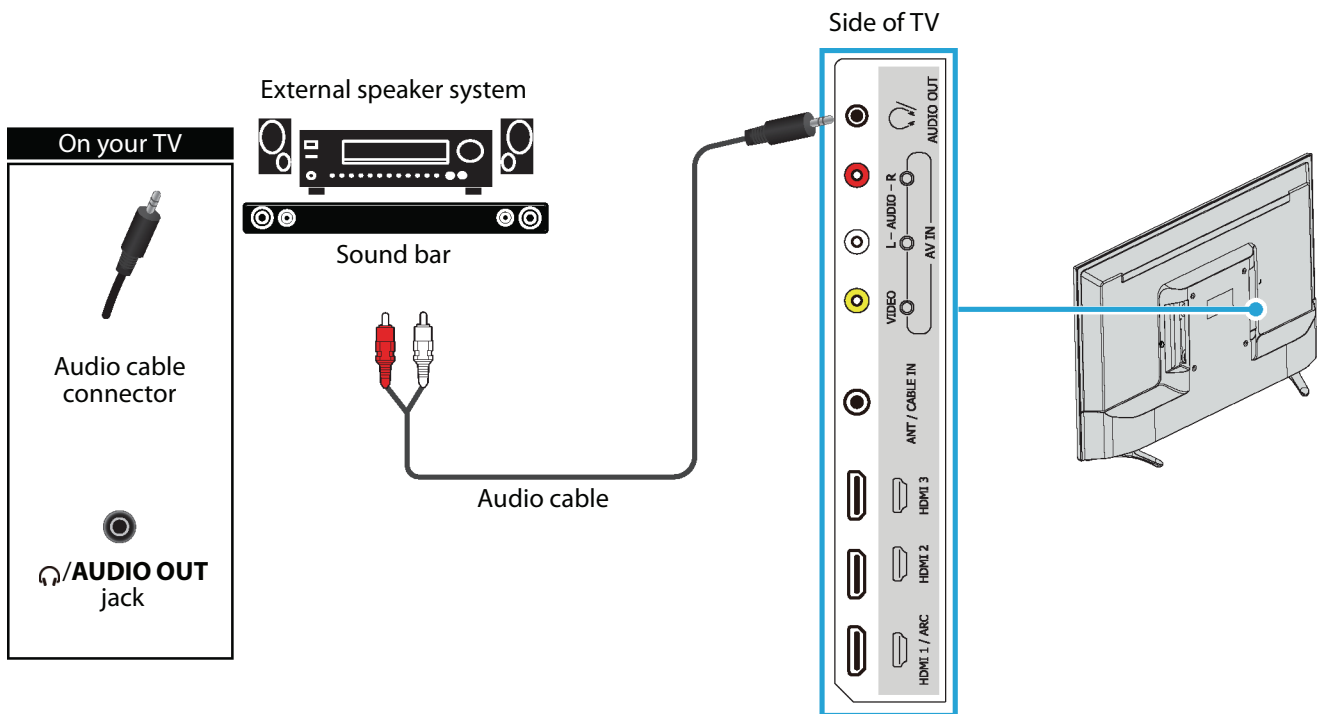

- 1 Make sure that your TV's power cord is unplugged and the external speaker system or sound bar is turned off.
- 2 Connect an audio cable (not provided) to the  **AUDIO OUT** jack on the side of your TV and to the **AUDIO IN** jacks on the external speaker system or sound bar.
- 3 Plug your TV's power cord into a power outlet, then turn on your TV.
- 4 Turn on the external speaker system or sound bar, then set it to the correct source. For more information, see the documentation that came with the external speaker system or sound bar.

Notes

- For information about selecting the audio out mode for an external speaker system or sound bar, see the **Headphones/Audio Out** option in "[Adjusting sound settings](#)" on page 43.
- You can connect headphones to the  **AUDIO OUT** jack. If you want to use headphones, you need to disconnect the external speaker system or sound bar.

Connecting a home theater system with multiple devices

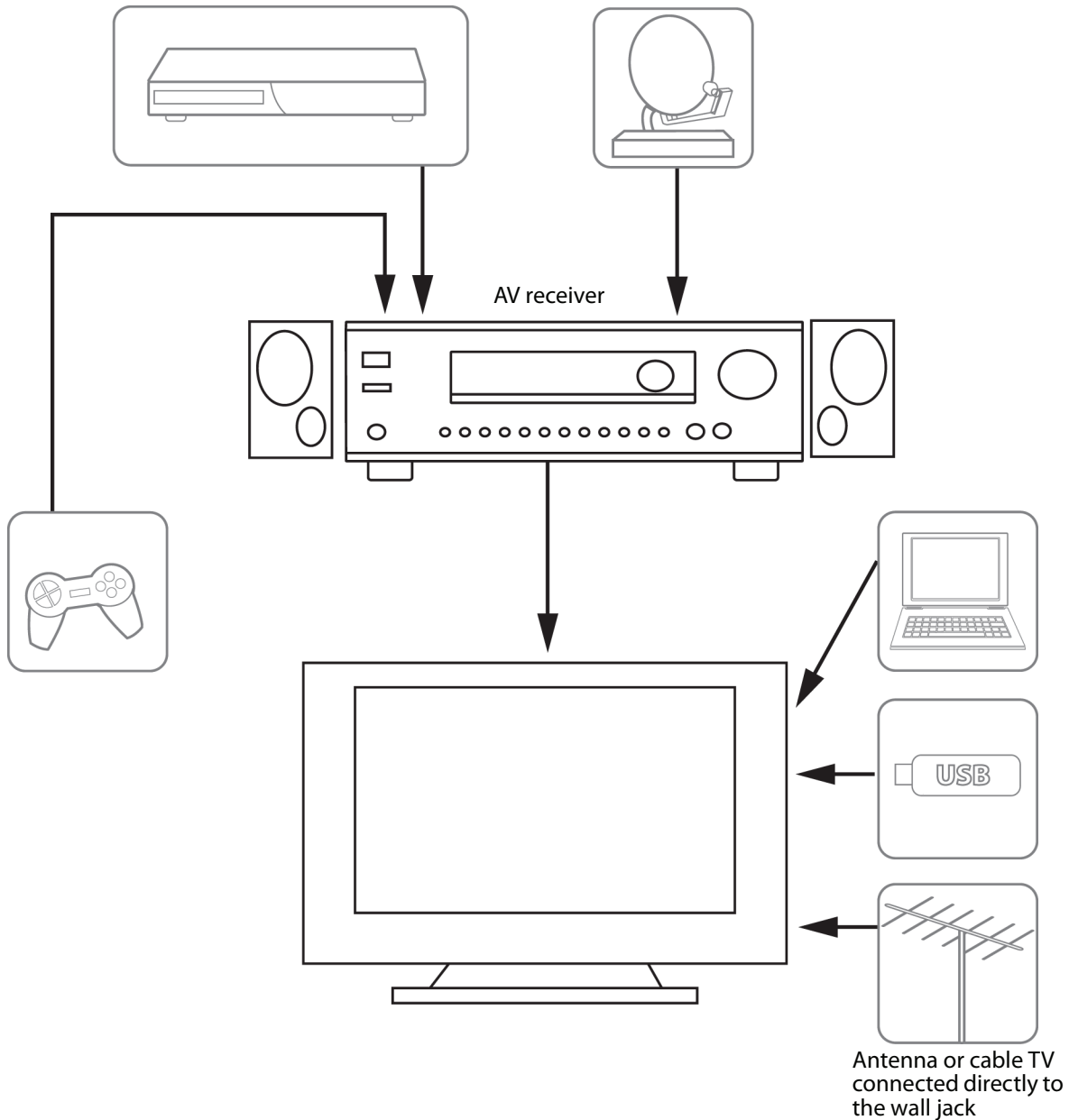

The connections you make depend on the video and audio jacks available on your devices. Refer to the documentation that came with your devices for connection information.

Just remember to use the best connection types available for the best picture and sound. For information about connection types, see ["What connection should I use?"](#) on page 12.

Connecting power

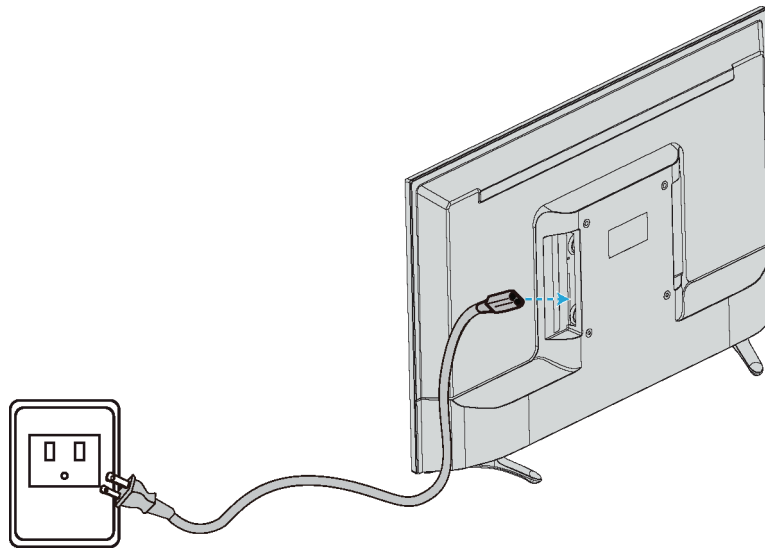

- 1 Connect the AC power cord to the **AC IN** connector on the side of your TV.
- 2 Connect the other end of the cord to a power outlet.

Caution

- Your TV should only be operated from the power source indicated on the label.
- Always unplug the AC power cord from the power outlet when you will not be using your TV for an extended period of time.

Using the remote control

Installing remote control batteries

- 1 While pressing the release latch on the back of the remote control, lift the battery compartment cover off of the remote control.

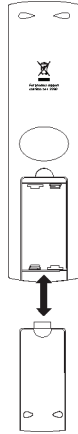

- 2 Insert two AAA batteries into the battery compartment. Make sure that you match the + and – symbols on the batteries with the + and – symbols in the battery compartment.

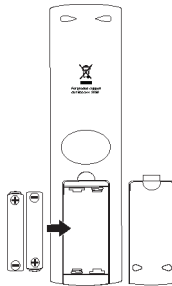

- 3 Replace the battery compartment cover.

Cautions

- Batteries should not be exposed to excessive heat, such as sunshine, heat registers, or fire.
- Battery chemicals can cause a rash. If the batteries leak, clean the battery compartment with a cloth. If chemicals touch your skin, wash immediately.
- Make sure that batteries are disposed of correctly. Do not burn or incinerate.

Notes

- Do not mix batteries of different types.
- Do not mix old and new batteries.
- Remove batteries when the charge is depleted.
- If the remote control is not going to be used for an extended period of time, remove the batteries.

Aiming the remote control

- Point the remote control towards the remote sensor on the front of your TV.

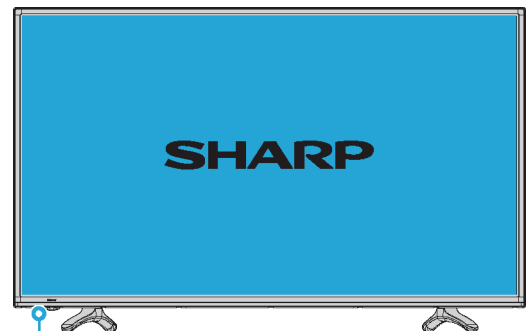

Remote control sensor

Programming universal remote controls

You can operate your Sharp TV with a new or existing universal remote control.

- 1 See the table in “[Viewing universal remote control codes](#)” for common codes. If you have problems programming your remote or need a different remote control code, see the instructions that came with the remote control or check the remote control manufacturer’s website for the latest remote control code information.
- 2 Follow your universal remote control’s instructions to enter the TV code you found in Step 1.

Tips

- If your universal remote control has a code search feature, run a code search to identify a code that matches your TV. See your universal remote control’s instructions for details.
- If your universal remote control has a “Learn” feature, you can manually program it using the Sharp TV remote to “teach” the commands one at a time. See your universal remote control’s instructions for details.

For additional help and information:

- Visit the remote control manufacturer’s website
- Call technical support for the universal remote control or cable/satellite company of the remote/set-top box you are trying to program.

Viewing universal remote control codes

You can view a list of universal remote control codes in the on-screen menu.

Tips

- The brand name is often visible on the front of the universal remote control, and the model number is often visible on the back.
- If your universal remote control is not listed, refer to your universal remote control’s instructions and try codes for the brands Orion, Emerson, Memorex, Sansui, Sylvania, or Zenith. You may need to try several codes before finding a match.

- 1 Press **MENU**.
- 2 Press **◀** or **▶** to highlight **Help**, then press **ENTER**.

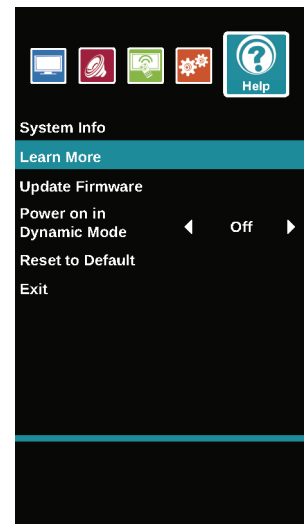

- 3 Press **▲** or **▼** to highlight **Learn More**, then press **ENTER** or **▶**.

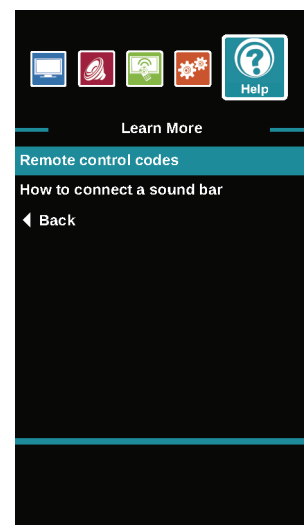

- 4 Press **▲** or **▼** to highlight **Remote control codes**, then press **ENTER** or **▶**. Your TV displays information about the universal remote codes that you can use to make your TV work with a universal remote.
- 5 Press **ENTER** to view a list of available codes.

Turning on your TV for the first time

The first time you turn on your TV, the *Easy Setup* wizard opens. The wizard guides you through setting up basic settings.

- 1 Make sure that you have:
 - Installed the remote control batteries. (See page 28 for details.)
 - Connected an antenna, cable TV, or satellite TV. (See page 13 through 16 for details.)
 - Connected the power cord. (See page 27 for details.)
- 2 Press **⏻** (power) to turn on your TV.



- 3 Press **▲** or **▼** to highlight a language, then press **ENTER**.

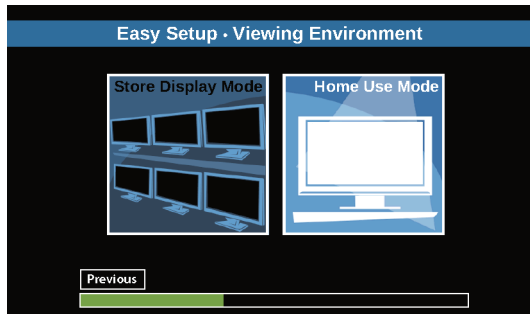

- 4 Press **◀** or **▶** to highlight **Home Use Mode** or **Store Display Mode**, then press **ENTER**.

If you selected **Store Display Mode**, a message asks if you are sure you want this mode. Select **OK** to continue using **Store Display Mode**, or select **Cancel** to change to **Home Use Mode**, then press **ENTER**. **Store Display Mode** is not an energy savings mode.

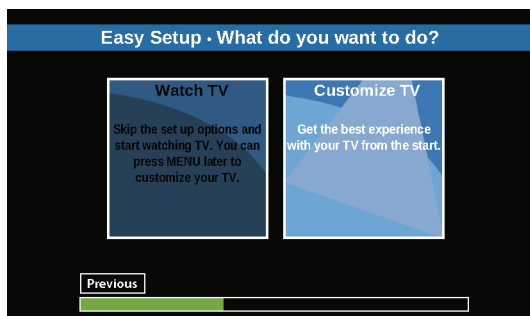

- 5 Press **◀** or **▶** to highlight an option, then press **ENTER**. You can select:
 - **Watch TV** to skip the customization options. You can press **MENU** later to access the on-screen menus and customize viewing settings. Go to "[Finish the wizard](#)" on page 31.
 - **Customize TV** to set viewing options to maximize your viewing experience. Go to "[Customize my TV](#)" on page 30.

Customize my TV

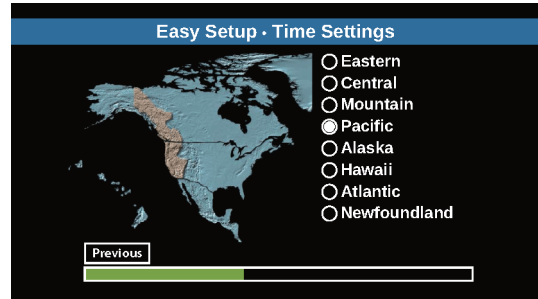

- 6 Press **▲** or **▼** to highlight a time zone, then press **ENTER**.

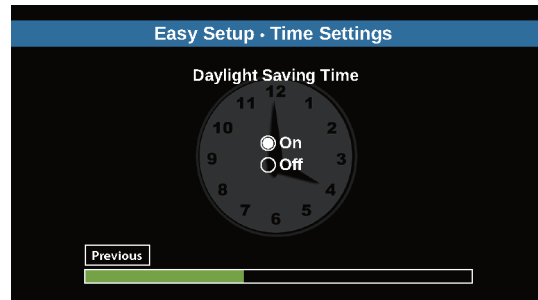

- 7 Press **▲** or **▼** to select **On** to turn on **Daylight Saving Time** or **Off** to turn off **Daylight Saving Time**, then press **ENTER**.

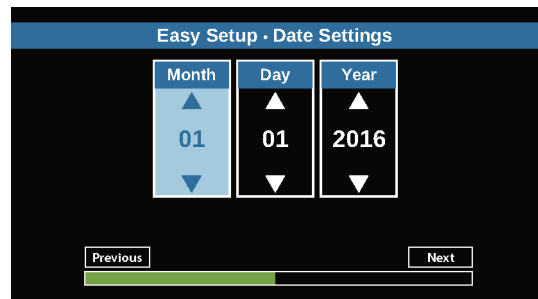

- 8 Press ◀▶ or **ENTER** to highlight **Month, Day, or Year**, then press ▲ or ▼ adjust the setting. When you are finished, use the arrow buttons to highlight **Next**, then press **ENTER**.

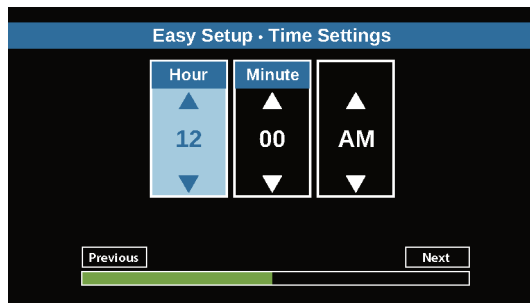

- 9 Press ◀▶ or **ENTER** to highlight **Hour, Minute,** or the **AM/PM** field, then press ▲ or ▼ adjust the option. When you are finished, use the arrow buttons to highlight **Next**, then press **ENTER**.

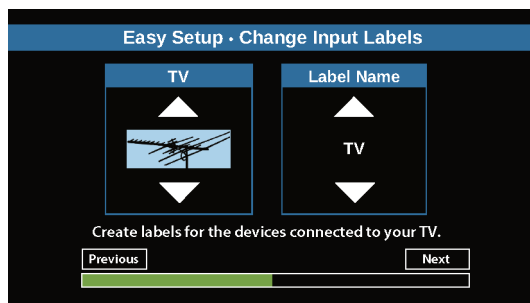

- 10 Press ▲ or ▼ to highlight a video input source, then press ▶ to move to the label area.
- 11 Press ▲ or ▼ to highlight a preset label or **Custom**.
- 12 If you select a preset label, press **ENTER**. The video input box on the left is selected so you can label a different video input source.
- OR
- If you select **Custom**, press **ENTER**, then press ▲ or ▼ to enter the first character in your custom label, then press ▶ to move to the next character position. Use the arrow buttons to enter additional characters or to move from character to character. You can enter 12 characters (letters or numbers). When you have finished creating your label, press **ENTER**. The video input box on the left is selected so you can label a different video input source.
- 13 Repeat Steps 10 through 12 to label additional video input sources.
- 14 When you have finished creating input labels, use the arrow buttons to highlight **Next**, then press **ENTER**.

Finish the wizard

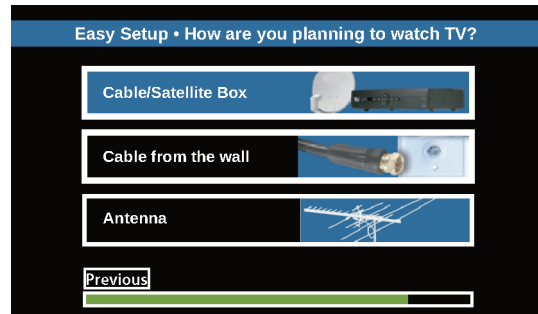

- 15 Press ▲ or ▼ to highlight **Cable/Satellite Box, Cable from the wall,** or **Antenna**, then press **ENTER**.
- If you select **Cable/Satellite Box**, a screen opens that shows you the ways you can connect the box.

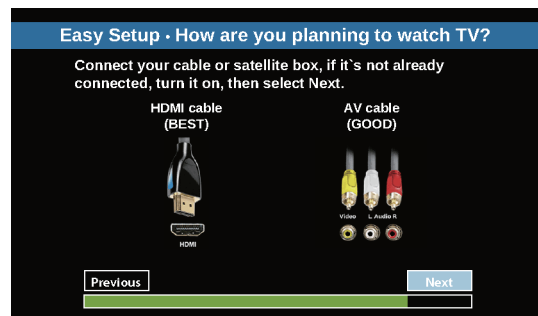

Press **ENTER**.

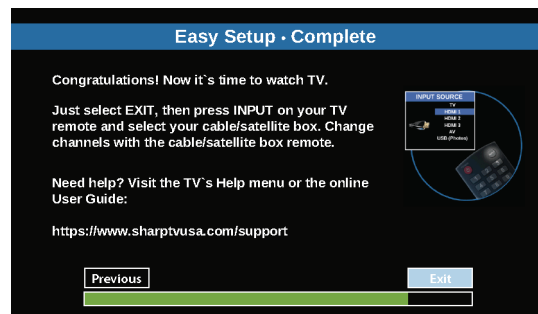

- If you select **Cable from the wall** or **Antenna**, your TV starts scanning for channels and displays a progress screen. The scan may take several minutes.

Note

You can press **EXIT**, or highlight **Skip** and press **ENTER**, to stop the auto channel search, but you will need to run the auto channel search again to create a channel list.

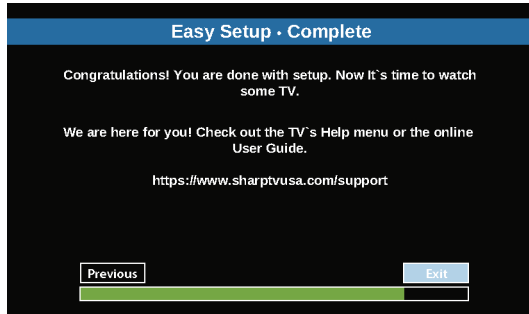

16 Press **ENTER** to close the wizard. If you selected:

- **Cable from the wall** or **Antenna**, your TV tunes to the first channel it found in the scan.
- **Cable/Satellite box**, press **INPUT** to open the **INPUT SOURCE** list, press **▲** or **▼** to select the video input (**HDMI** or **AV**) you connected the box to, then press **ENTER**. Your TV switches to the input you selected.

Understanding the basics

Turning your TV on or off

- 1 Make sure that the power cord is connected to a power outlet. See “[Connecting power](#)” on page 27.
- 2 Press **⏻/INPUT** to turn on your TV. The power indicator turns off.
- 3 Press **⏻/INPUT** again to turn off your TV. Your TV enters standby mode, and the power indicator turns red.

Warning

When your TV is in standby mode, it is still receiving power. To completely disconnect power, unplug the power cord.

Note

If your TV does not receive an input signal for several minutes, it automatically goes into standby mode.

Selecting the video input source

- 1 Turn on your TV, then press **INPUT**.

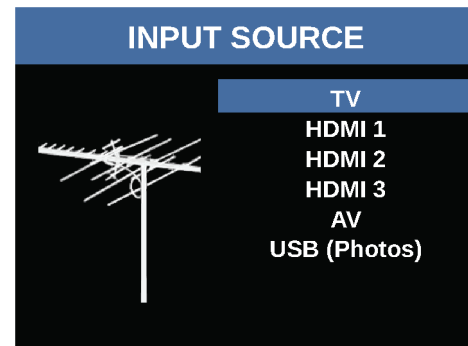

- 2 Press **▲** or **▼** to select a video input source, then press **ENTER**.

On-screen menu overview

Notes

- Depending on the signal source selected, you may see different options on your screen.
- Menu items that are not selectable are grayed out.

Picture menu (TV mode)



Sound menu (TV mode)

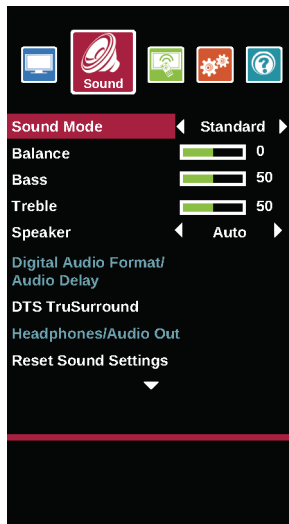

Channels menu (TV mode)

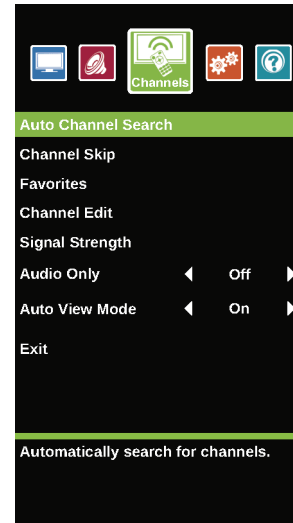

Settings menu (TV mode)

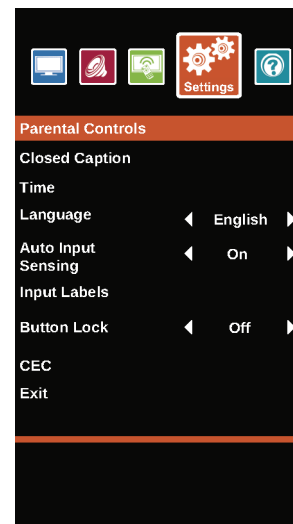

Help menu (TV mode)

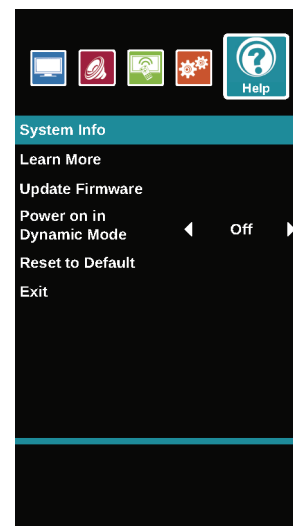

PHOTOS menu (USB mode)

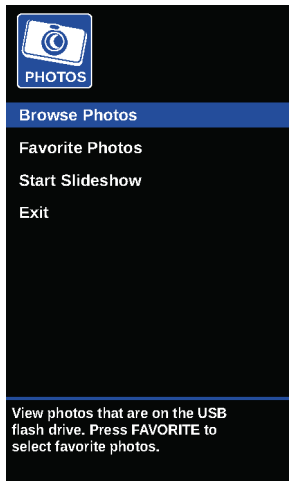

Navigating the menus

Press **MENU** to open the on-screen menu.

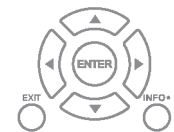

Press the right or left arrow to move the cursor on the screen or to adjust a selected item.

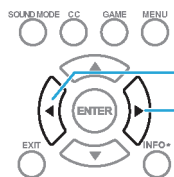

Press the up or down arrow to select menu options.

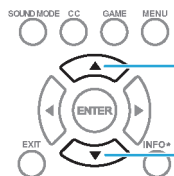

Press **ENTER** to confirm a selection or enter a sub-menu.

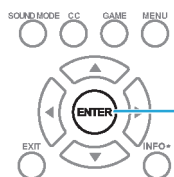

Press **MENU** to return to the previous menu.

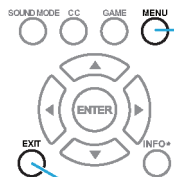

Press **EXIT** to close the menu.

Selecting a channel

- Press **CH** \wedge or **CH** \vee to go to the next or previous channel on the memorized channel list.
- Press the number buttons to enter the channel number you want, then wait for the channel to change or press **ENTER** to immediately change the channel.
- To select a digital sub-channel, press the number buttons to enter the main digital channel, press \bullet (sub-channel), then press the number button for the sub-channel. Wait for the channel to change, or press **ENTER** to immediately change the channel. For example, to tune to channel 5.1, press **5**, \bullet (sub-channel), then **1**.

Note

Button presses must be within three seconds of each other.

- Press \curvearrowright (previous) to go to the last viewed channel.
- Press **FAVORITE** to open the favorite channel list, press \blacktriangle or \blacktriangledown to highlight a channel, then press **ENTER**. For information about setting up a favorite channel list, see "Setting up a favorite channel list" on page 46.

Note

If a list has more than one page, press \blacktriangle or \blacktriangledown to scroll through the pages.

Adjusting the volume

- Press **VOL+** or **VOL-** to increase or decrease the volume.
- Press MUTE to turn off the sound. Press MUTE again to turn the sound back on.

Viewing channel information

- Press **INFO*** to view an information banner. The information banner shows the current program information such as channel number, video input source, and resolution.
 - Digital channel information—Displays the channel number, station name, channel label, broadcast program name, TV rating, signal type, audio information, resolution, current time, signal strength, day of the week, date and current program start and end times, if provided by the broadcaster.
 - Analog channel information—Displays channel number, channel label, signal type, audio information, day of the week, date, and resolution, if provided by the broadcaster.

Using CEC Control

CEC Control lets you control HDMI CEC-compatible devices connected to the HDMI jacks on your TV using the remote control that came with your TV. To use CEC Control, you must set the **CEC Control** setting on the *Settings* · *CEC* menu to **On**.

Notes

- HDMI cables must be used to connect HDMI CEC-compatible devices to your TV.
- The connected device's HDMI CEC feature must be turned on.
- If you connect an HDMI device that is not HDMI CEC-compatible, all of the **CEC** features do not work.
- Depending on the connected HDMI device, the **CEC** feature may not work.

Turning CEC Control on or off

- 1 Press **MENU**.
- 2 Press **◀** or **▶** to highlight **Settings**, then press **ENTER**.

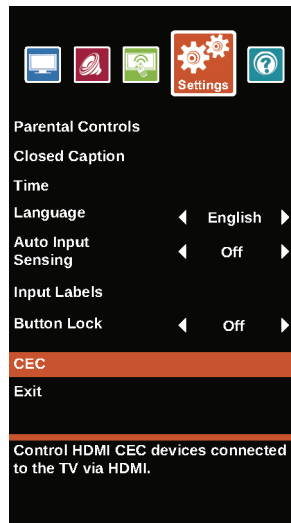

- 3 Press **▲** or **▼** to highlight **CEC**, then press **ENTER**.



- 4 Press **▲** or **▼** to highlight **CEC Control**, then press **ENTER** or **▶** to access the option.
- 5 Press **◀** or **▶** to highlight **On** or **Off**, then press **ENTER**.
- 6 Press **MENU** to return to the previous menu, or press **EXIT** to close the menu.

Turning Device Auto Power Off on or off

When CEC Control is set to **On**, **Device Auto Power Off** automatically turns off HDMI CEC devices when you turn off your TV.

- 1 Press **MENU**.
- 2 Press **◀** or **▶** to highlight **Settings**, then press **ENTER**.

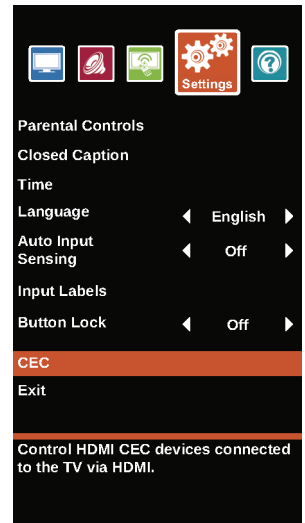

- 3 Press **▲** or **▼** to highlight **CEC**, then press **ENTER**.

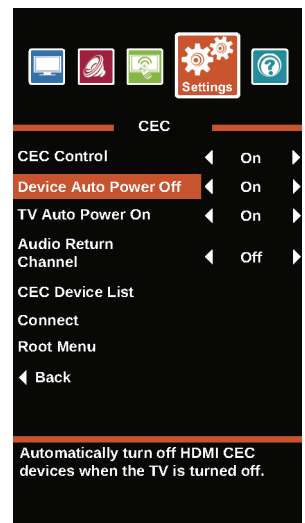

- 4 Make sure that the **CEC Control** option is turned on. See "Turning CEC Control on or off" on page 35.
- 5 On the *Settings* · *CEC* menu, press **▲** or **▼** to highlight **Device Auto Power Off**, then press **ENTER** or **▶** to access the option.
- 6 Press **◀** or **▶** to highlight **On** (turns off the connected devices when you turn off your TV) or **Off** (does not turn off the connected devices when you turn off your TV), then press **ENTER**.
- 7 Press **MENU** to return to the previous menu, or press **EXIT** to close the menu.

Turning TV Auto Power On on or off

TV Auto Power On automatically turns on your TV when an HDMI CEC device is turned on, if the device has this feature.

- 1 Press **MENU**.
- 2 Press ◀ or ▶ to highlight **Settings**, then press **ENTER**.

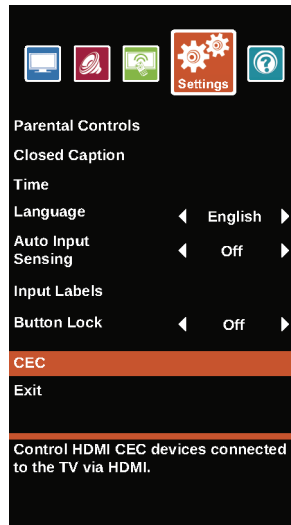

- 3 Press ▲ or ▼ to highlight **CEC**, then press **ENTER**.



- 4 Make sure that the **CEC Control** option is turned on. See [“Turning CEC Control on or off”](#) on page 35.
- 5 On the *Settings* · *CEC* menu, press ▲ or ▼ to highlight **TV Auto Power On**, then press **ENTER** or ▶ to access the option.
- 6 Press ◀ or ▶ to highlight **On** (turns on your TV when you turn on the connected device) or **Off** (does not turn on your TV when you turn on the connected device), then press **ENTER**.
- 7 Press **MENU** to return to the previous menu, or press **EXIT** to close the menu.

Turning Audio Return Channel on or off

When CEC Control is turned on and you have connected an audio receiver to your TV, turning on **Audio Return Channel** lets you use your TV’s remote control to control the volume on the audio receiver.

- 1 Press **MENU**.
- 2 Press ◀ or ▶ to highlight **Settings**, then press **ENTER**.

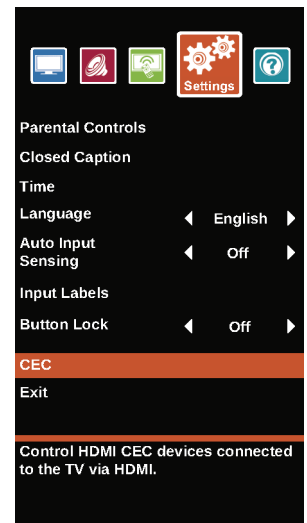

- 3 Press ▲ or ▼ to highlight **CEC**, then press **ENTER**.

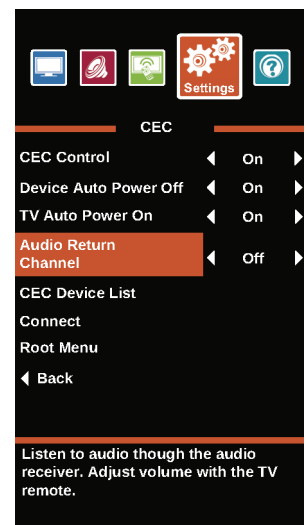

- 4 Make sure that the **CEC Control** option is turned on. See [“Turning CEC Control on or off”](#) on page 35.
- 5 On the *Settings* · *CEC* menu, press ▲ or ▼ to highlight **Audio Return Channel**, then press **ENTER** or ▶ to access the option.
- 6 Press ◀ or ▶ to highlight **On** (your TV’s remote control controls the connected audio receiver’s volume) or **Off** (your TV’s remote control does not control the connected audio receiver’s volume), then press **ENTER**.
- 7 Press **MENU** to return to the previous menu, or press **EXIT** to close the menu.

Displaying a list of CEC-compatible devices

You can display a list of HDMI CEC devices that are connected to your TV.

- 1 Press **MENU**.
- 2 Press **◀** or **▶** to highlight **Settings**, then press **ENTER**.

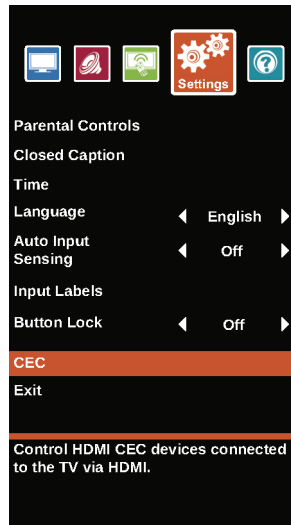

- 3 Press **▲** or **▼** to highlight **CEC**, then press **ENTER**.

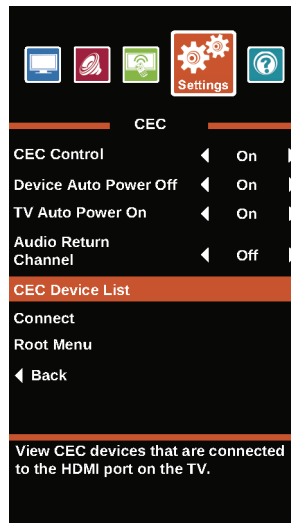

- 4 Make sure that the **CEC Control** option is turned on. See ["Turning CEC Control on or off"](#) on page 35.
- 5 On the *Settings* · *CEC* menu, press **▲** or **▼** to highlight **CEC Device List**, then press **ENTER**. A list of the HDMI CEC-compatible devices you have connected appears.
- 6 Press **MENU** to return to the previous menu, or press **EXIT** to close the menu.

Selecting a CEC-compatible device

When you have more than one CEC-compatible device connected, you can select the device you want to use.

- 1 Press **INPUT**, press **▲** or **▼** to highlight the CEC-compatible device you want to wake, then press **ENTER**.
- 2 Press **MENU**.
- 3 Press **◀** or **▶** to highlight **Settings**, then press **ENTER**.

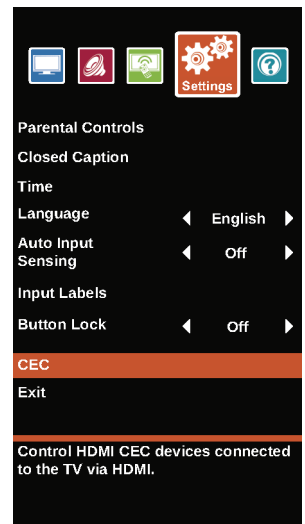

- 4 Press **▲** or **▼** to highlight **CEC**, then press **ENTER**.

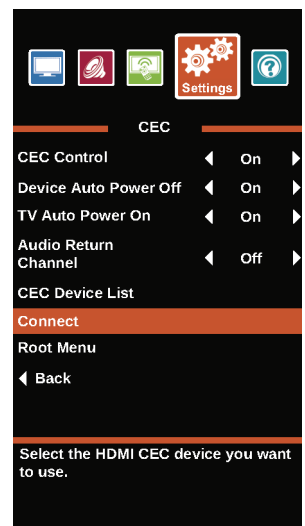

- 5 Make sure that the **CEC Control** option is turned on. See ["Turning CEC Control on or off"](#) on page 35.
- 6 On the *Settings* · *CEC* menu, press **▲** or **▼** to highlight **Connect**, then press **ENTER**. A list of HDMI CEC-compatible devices you have connected opens.
- 7 Press **▲** or **▼** to highlight the HDMI CEC-compatible device you want to connect to, then press **ENTER**.
- 8 Press **MENU** to return to the previous menu, or press **EXIT** to close the menu.

Opening a CEC-compatible device's root menu

You can open a CEC-compatible device's root menu, then use your TV's remote control to control the device, if the device has this feature.

- 1 Press **INPUT**, press **▲** or **▼** to highlight an HDMI input, then press **ENTER**.
- 2 Press **MENU**.
- 3 Press **◀** or **▶** to highlight **Settings**, then press **ENTER**.

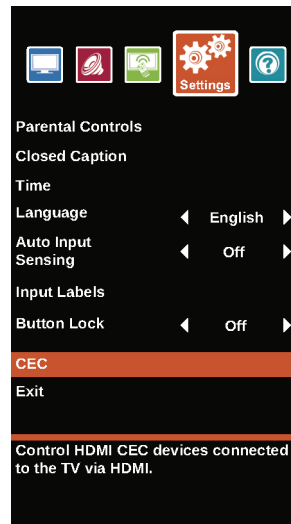

- 4 Press **▲** or **▼** to highlight **CEC**, then press **ENTER**.

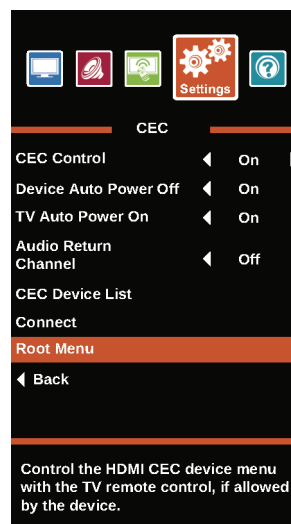

- 5 Make sure that the **CEC Control** option is turned on. See "[Turning CEC Control on or off](#)" on page 35.
- 6 On the *Settings* · *CEC* menu, press **▲** or **▼** to highlight **Root Menu**, then press **ENTER**. The device's root menu opens, and you can use your TV's remote control to control the device.
- 7 Press **MENU** to return to the previous menu, or press **EXIT** to close the menu.

Using a USB flash drive

You can connect a USB flash drive to your TV to view compatible JPEG pictures.

Notes

- Never remove the USB flash drive or turn off your TV while viewing JPEG pictures.
- The JPEG picture viewer only supports JPEG format images (with ".jpg" file extensions) and not all JPEG files are compatible with your TV.

Switching to USB mode

- 1 Make sure that you have connected the USB flash drive to the USB port on your TV.
- 2 If your TV is turned on when you connect the USB flash drive, press **▲** or **▼** to highlight **Yes** in the message that appears, then press **ENTER**. The *PHOTOS* menu opens.

OR

If you connected the USB flash drive, then changed to a different video input source, press **INPUT** to open the *INPUT SOURCE* list, press **▲** or **▼** to highlight **USB (Photos)**, then press **ENTER**. The *PHOTOS* menu opens.

Note

To exit USB mode, press **INPUT** to open the *INPUT SOURCE* list, then select another input source.

Browsing photos

- 1 Switch to USB mode. See "[Switching to USB mode](#)" on page 38.

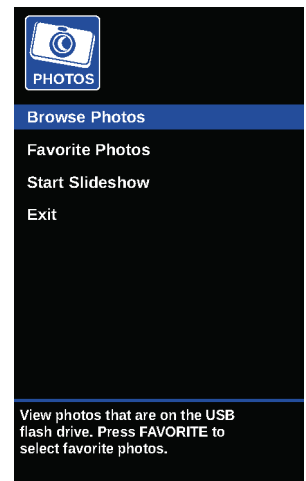

- Press **▲** or **▼** to highlight **Browse Photos**, then press **ENTER**. The screen displays folder names and photo files stored on the USB flash drive in a thumbnail index with the first photo or folder highlighted.

Note

Photos are shown in the order they appear on the USB flash drive. They may not be listed in file name order.

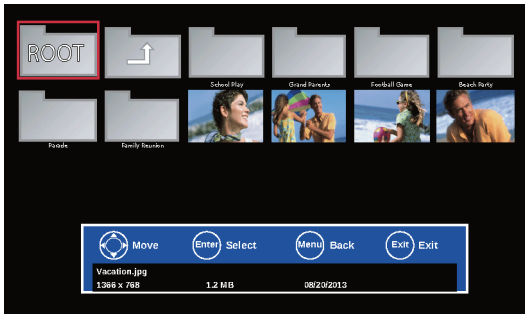

- To navigate the thumbnail index screen, press:
 - ▲ ▼ ◀ ▶ to browse through the files and folders.
 - ENTER** to view a highlighted photo full-screen or open a highlighted folder.
 - MENU** to open the *PHOTOS* menu.
 - FAVORITE** to add or remove a photo from the favorite photo list. A heart appears on a photo that has been added to the favorite photo list.

When a photo is displayed full-screen, a control bar appears at the bottom of the photo. The file name, picture resolution, size, and date are displayed on the bottom of the control bar. If you do not press a button within 10 seconds, the control bar closes. Press **INFO*** to open the control bar again.

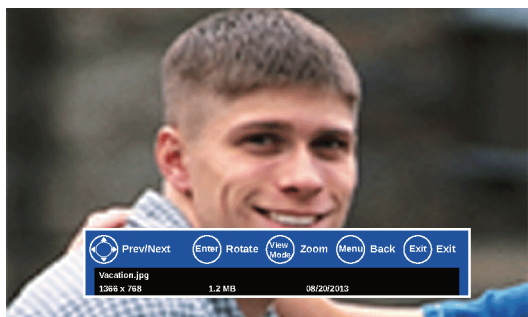

- To navigate on the photo screen, press:
 - ◀ to go to the previous photo.
 - ▶ to go to the next photo.
 - ENTER** to rotate the photo clockwise.
 - VIEW MODE** one or more times to enlarge the image by x2 or x4 or to select **Fill** (to fill the screen). You can press ▲ ▼ ◀ ▶ to pan the photo.
 - EXIT** to return to the thumbnail index.
 - MENU** to return to the *PHOTOS* menu.

Viewing favorite photos

After you create your favorite photo list, you can browse among your favorite photos quickly.

- Switch to USB mode. See [“Switching to USB mode”](#) on page 38.

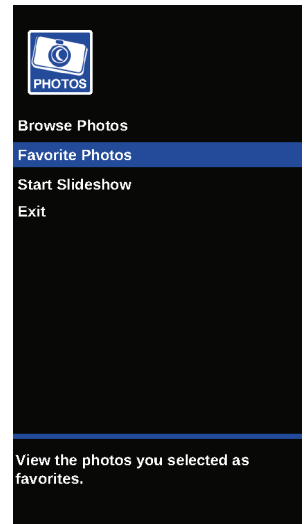

- Press **▲** or **▼** to highlight **Favorite Photos**, then press **ENTER**. A thumbnail index of your favorite photos opens. A heart appears on a favorite photo.

Note

Photos are shown in the order they appear on the USB flash drive. They may not be listed in file name order.



You select photos and navigate on the photo screen in the same way you do when you are browsing through photos. For more information, see [“Browsing photos”](#) on page 38.

Viewing photos in a slideshow

You can view your photos in a slideshow.

- 1 Switch to USB mode. See “Switching to USB mode” on page 38.
- 2 If the photos you want to view are in a folder on the USB flash drive, select the folder. For information about selecting a folder, see “Browsing photos” on page 38 or “Viewing favorite photos” on page 39.
- 3 Press **MENU**.

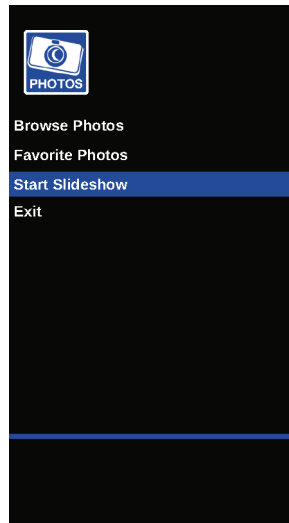

- 4 Press **▲** or **▼** to highlight **Start Slideshow**, then press **ENTER**. A slideshow starts with the first photo in the current folder.
- 5 To control the slideshow, press:
 - **ENTER**, **▶** (play), or **||** (pause) to pause or start the slideshow.
 - **EXIT** or **■** (stop) to exit the slideshow and go to the thumbnail index.
 - **MENU** to go to the *PHOTOS* menu.

Adjusting the picture

Adjusting the TV picture

You can adjust various settings to improve the quality of the TV picture. Also, you can reset all picture settings to the factory default.

- 1 Press **MENU**.
- 2 Press **◀** or **▶** to highlight **Picture**, then press **ENTER**.

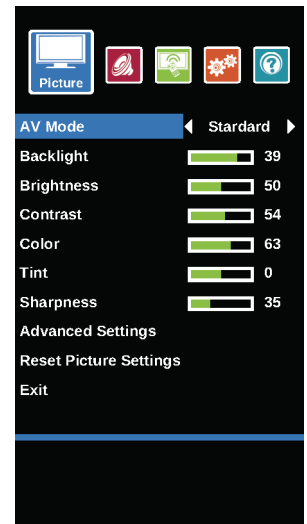

- 3 Press **▲** or **▼** to highlight an option, then press **ENTER** or **▶** to access the option. You can select:
 - **AV Mode**—Selects the picture mode. You can select:
 - **Standard**—(the backlight brightness is decreased). Your TV has a backlight that provides light for displaying a picture. By reducing the amount of light, your TV uses less energy.
 - **Movie**—(a finely detailed picture). Adjusts the brightness and contrast and lowers the sharpness for a more realistic picture. This selection is good for watching the highest quality video such as Blu-ray Discs, DVDs, and HDTV.
 - **Game**—Adjusts the picture for the ultimate gaming experience. This option is available when the video input source is set to HDMI or AV.
 - **User**—(customized picture). Lets you manually adjust picture settings such as brightness, contrast, and sharpness.
 - **Dynamic**—(a bright and vivid picture). Significantly increases the contrast, brightness, and sharpness. This selection is good for video games, animation, and in bright light environments.
 - **Natural**—(a standard picture). Moderately increases the contrast, brightness, and sharpness. This selection is good for standard TV broadcasts.

Note

You can also press **AV MODE** to select the picture mode.

- **Backlight**—Sets the overall brilliance of the screen.
- **Brightness**—Adjusts the brightness of the dark areas of the picture.
- **Contrast**—Adjusts the brightness of the light areas of the picture.
- **Color**—Adjusts the color intensity of the picture. A low setting may make the color look faded. A high setting may make the color look artificial.
- **Tint**—Adjusts the color balance of the picture. Use this control to make skin tones look more natural.
- **Sharpness**—Adjusts the color detail of images. If you set this control too high, dark images may appear with light or white edges.
- **Advanced Settings**—Opens the *Advanced Settings* menu where you can adjust additional video options.

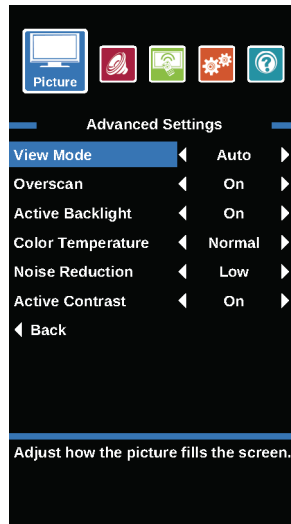

- **View Mode**—Adjusts how the picture fills the screen (aspect ratio). You can select:

Aspect ratio options	Example
<p>Normal: Original aspect ratio is preserved. You might see black bars if the original content is not widescreen (16:9).</p>	
<p>Zoom: Expands the image to fill the screen. The top and bottom of the image may be cropped.</p>	
<p>Wide: Use this option to view content recorded in widescreen (16:9) format.</p>	

Aspect ratio options	Example
<p>Cinema: Stretches the image at the edges, but keeps a clear image in the center.</p>	
<p>Auto: Automatically adjusts the image based on the screen size and the TV program. Select this option if you don't know which aspect ratio to choose. Note: Auto is only available when Auto View Mode in the <i>Channels</i> menu is set to On.</p>	

Note
You can also press **VIEW MODE** to select the aspect ratio.

- **Overscan**—Extends text and images past the screen edges to hide edge artifacts. You can select **On** or **Off**.
 - **Active Backlight**—Enhances the contrast ratio between light and dark areas of the picture. You can select **On** or **Off**.
 - **Color Temperature**—Selects the color temperature. You can select **Cool** (to enhance the blues), **Normal**, or **Warm** (to enhance the reds).
 - **Noise Reduction**—Selects the noise reduction mode to reduce picture noise (snow). You can select **Off**, **Low**, **Middle**, or **High**.
 - **Active Contrast**—Automatically adjusts picture detail and brightness. You can select **On** or **Off**.
 - **Reset Picture Settings**—Resets all picture settings to factory mode.
- 4 Press ◀ or ▶ to adjust the option.
 - 5 Press **MENU** to return to the previous menu, or press **EXIT** to close the menu.

Automatically adjusting the aspect ratio

Auto View Mode automatically changes how the picture looks on the screen (aspect ratio) based on the TV program you are viewing.

- 1 Press **MENU**.
- 2 Press ◀ or ▶ to highlight **Channels**, then press **ENTER**.

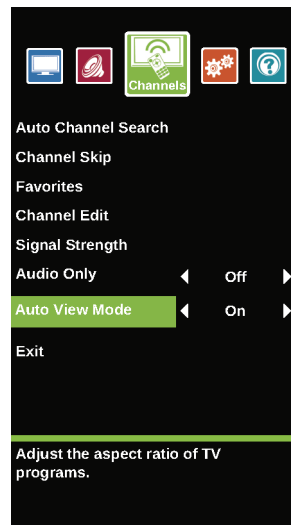

- 3 Press ▲ or ▼ to highlight **Auto View Mode**, then press **ENTER** or ▶ to access the option.
- 4 Press ◀ or ▶ to select **On** (automatically adjust the aspect ratio) or **Off** (does not automatically adjust the aspect ratio), then press **ENTER**.
- 5 Press **MENU** to return to the previous menu, or press **EXIT** to close the menu.

Note

You can also press **VIEW MODE** to select the aspect ratio.

Setting the power on picture mode

You can set the picture mode your TV uses when you turn it on.

- 1 Press **MENU**.
- 2 Press ◀ or ▶ to highlight **Help**, then press **ENTER**.

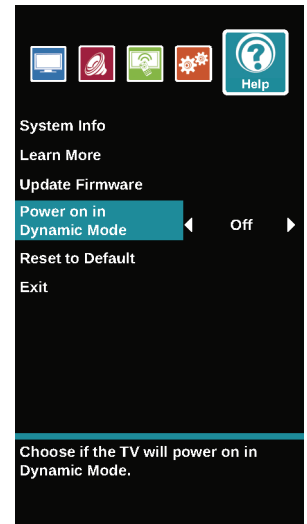

- 3 Press ▲ or ▼ to highlight **Power on in Dynamic Mode**, then press **ENTER** or ▶ to access the option.
- 4 Press ◀ or ▶ to select **On** (when you turn on your TV, it will be in **Dynamic** picture mode) or **Off** (when you turn on your TV, it will be in the picture mode it was in before you turned it off), then press **ENTER**.
- 5 Press **MENU** to return to the previous menu, or press **EXIT** to close the menu.

Adjusting the sound

Adjusting sound settings

You can adjust sound settings to improve the sound quality. You also can reset all sound settings to the factory default.

- 1 Press **MENU**.
- 2 Press ◀ or ▶ to highlight **Sound**, then press **ENTER**.

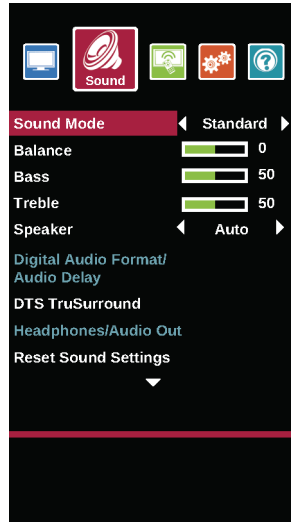

- 3 Press ▲ or ▼ to highlight an option, then press **ENTER** or ▶ to access the option. You can select:

- **Sound Mode**—Selects the sound mode. You can select:
 - **Standard**—Balances treble and bass. This setting is good for watching standard TV broadcasts.
 - **Movie**—Enhances treble and bass for a rich sound experience. This setting is good for watching DVDs, Blu-ray Discs, and HDTV.
 - **Music**—Preserves the original sound. This setting is good for listening to music.
 - **Voice**—Enhances vocals for TV audio. This setting is good for watching news broadcasts.
 - **User**—Lets you manually adjust sound settings.
- **Balance**—Adjusts the balance between the left and right audio channels.
- **Bass**—Adjusts the low sounds.
- **Treble**—Adjusts the high sounds.
- **Speaker**—Selects where to play TV audio. When you connect headphones to your TV, audio plays through both the headphones and the TV speakers. You can select:
 - **Auto** (default setting)—Automatically turns off the TV speakers when you connect a device to the ◻/AUDIO OUT jack. When the device is disconnected, the TV speakers turn on automatically.
 - **On**—Always plays the audio through the TV speakers. If a device is connected to the ◻/AUDIO OUT jack, the audio is played through the TV speakers only.
 - **Off**—Turns off the TV speakers and plays the audio only through the device connected to the ◻/AUDIO OUT jack. If you disconnect the device, the TV speakers remain turned off.

- **Digital Audio Format/Audio Delay**—Sends digital audio to an external audio system. You can select:
 - **Audio Format**—Selects how the digital audio is sent to the external audio system. You can select:
 - **Pass Thru**—Outputs the original digital audio sound.
 - **PCM**—Outputs audio in 2-channel stereo.
 - **Audio Delay**—Fine tunes the audio when it is not in sync with the video.
- **DTS TruSurround**—Sets your preferences for audio enhancement features. You can select:
 - **Surround Sound**— You can select **On** or **Off** to add virtual surround sound to the TV speakers.
 - **Dialog Clarity**— You can select **Low**, **Medium**, or **High** to provide dialog enhancement for clear and intelligible vocals.
- **Headphones/Audio Out**—You can use the ◻/AUDIO OUT jack on the side of your TV to connect headphones, a home theater system, or a sound bar. When a device is connected to the ◻/AUDIO OUT jack, the TV speakers are muted. You can select:
 - **Headphones/Audio Out**—Select this option to use the remote control that came with your TV to control the audio from the headphones, home theater system, sound bar, or external speaker system you connected to the ◻/AUDIO OUT jack.
 - **Audio Out Fixed**—Select this option to use the remote control that came with the home theater system, sound bar, or external speaker system you connected to the ◻/AUDIO OUT jack to control the audio.

This option is only available when a device is connected to the ◻/AUDIO OUT jack.

- **Reset Sound Settings**—Reset all audio settings to factory defaults.
- **Analog TV Audio**—(Analog channels only) Selects the audio mode. You can select:
 - **Mono**—Select this option if there is noise or static on weak stereo broadcasts.
 - **Stereo**—Select this option for programs broadcast in stereo.
 - **SAP**—Select this option to listen to a secondary audio program, if available.
- **Audio Language**—(Digital channels only) Selects an alternate audio language, if available.

Note

You can also press **AUDIO** one or more times to select the audio mode.

- 4 Press ◀ or ▶ to adjust the option.
- 5 Press **MENU** to return to the previous menu, or press **EXIT** to close the menu.

Selecting the audio out mode

If your TV is on when you connect a device to the **Ⓜ/AUDIO OUT** jack on the side of your TV, a screen opens where you select which audio out mode you want to use.

- 1 Connect headphones, an amplifier, a home theater system, or a sound bar to the **Ⓜ/AUDIO OUT** jack on the side of your TV.



- 2 Press **◀** or **▶** to highlight the audio out mode you want to use, then press **ENTER**. You can select:
 - **Headphones/Audio Out**—Select this option to use the remote control that came with your TV to control the audio from the headphones, home theater system, sound bar, or external speaker system you connected to the **Ⓜ/AUDIO OUT** jack.
 - **Audio Out Fixed**—Select this option to use the remote control that came with the home theater system, sound bar, or external speaker system you connected to the **Ⓜ/AUDIO OUT** jack to control the audio.

Playing TV audio only

You can turn off the picture on your TV and listen to the program audio only.

- 1 Press **MENU**,
- 2 Press **◀** or **▶** to highlight **Channels**, then press **ENTER**.

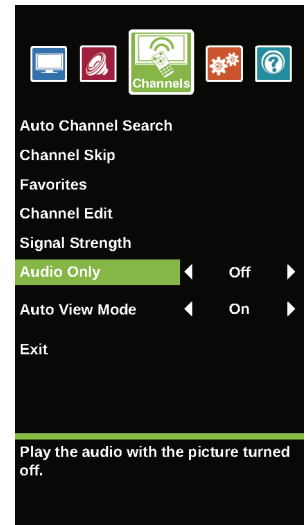

- 3 Press **▲** or **▼** to highlight **Audio Only**, then press **ENTER** or **▶** to access the option.
- 4 Press **◀** or **▶** to select **On**.
- 5 Press **MENU** to return to the previous menu, or press **EXIT** to close the menu.

Notes

- The picture turns off in about five seconds.
- **Audio Only** works only when the input source is TV and your TV is receiving a broadcast signal.
- To exit audio only mode, press any button. When you exit audio only mode, the **Audio Only** option is automatically reset to **Off**.

Changing channel settings

Automatically scanning for channels

When you scan for channels, your TV searches for channels with signals and stores the channel information in the channel list. When you press **CH** \wedge or **CH** \vee , your TV goes to the next or previous channel in the channel list.

If the TV signal source changes, for example you change from an outdoor antenna to cable TV (no box), you need to scan for channels.

- 1 Press **MENU**.
- 2 Press \blacktriangleleft or \blacktriangleright to highlight **Channels**, then press **ENTER**.

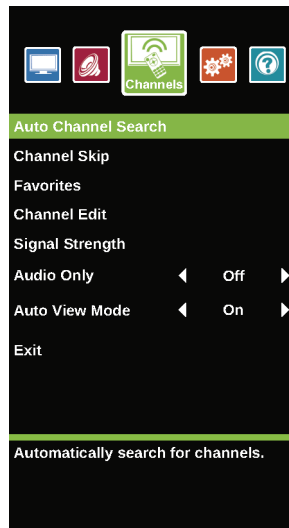

- 3 Press \blacktriangle or \blacktriangledown to highlight **Auto Channel Search**, then press **ENTER**.

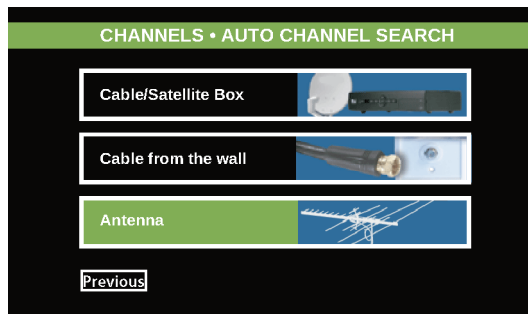

- 4 Press \blacktriangle or \blacktriangledown to highlight **Cable/Satellite Box**, **Cable from the wall**, or **Antenna**, then press **ENTER**.

- A If you select **Cable/Satellite Box**, a screen opens to show the ways you can connect a cable or satellite box.



Press **ENTER**. A message tells you that setup is complete. Press **ENTER** to close the menu.

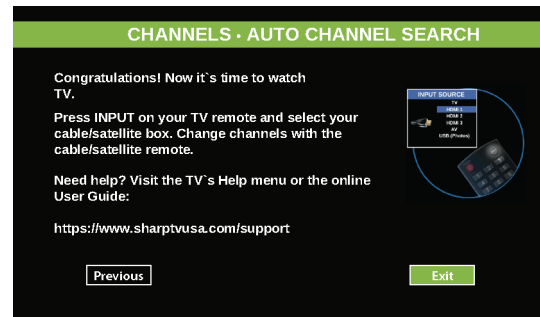

- B If you select **Cable from the wall** or **Antenna**, your TV scans for channels. The scan may take several minutes. When a message tells you that setup is complete, press **ENTER** to close the menu.

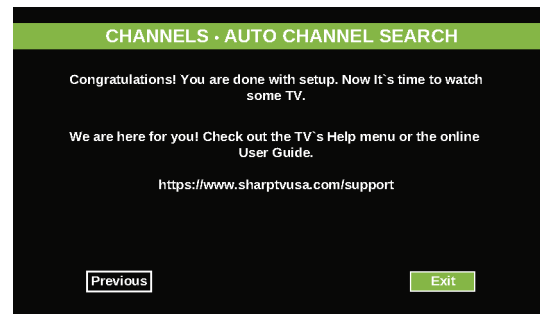

Note

You can press **EXIT** to stop the auto channel search, but you will need to run the auto channel search again to create a channel list.

Hiding channels

You can hide channels in the channel list. When you press **CH** \wedge or **CH** \vee , your TV skips the hidden channels. You can still tune to a hidden channel by pressing the number buttons for the channel.

- 1 Press **MENU**.
- 2 Press \leftarrow or \rightarrow to highlight **Channels**, then press **ENTER**.

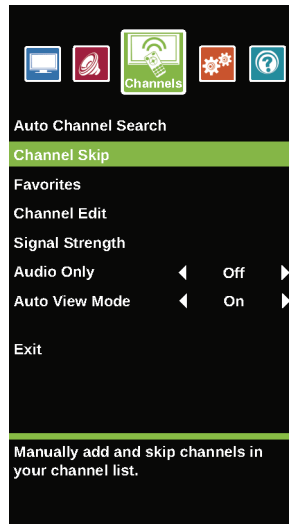

- 3 Press \blacktriangle or \blacktriangledown to highlight **Channel Skip**, then press **ENTER** or \rightarrow to access the option.

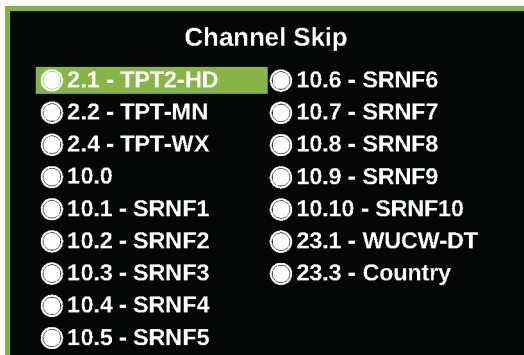

- 4 Press \blacktriangle \blacktriangledown \leftarrow or \rightarrow to highlight the channel you want to hide, then press **ENTER**. Each channel has a circle to the left. When you hide a channel the circle is empty.

Notes

- If you highlight a channel in the list for two to four seconds, your TV displays the channel in the background.
- A channel with a filled circle is not hidden. A channel with an empty circle is hidden.
- If the list has more than one page, press \blacktriangle or \blacktriangledown to scroll through the pages.

- 5 Press **MENU** to return to the previous menu, or press **EXIT** to close the menu.

Setting up a favorite channel list

You can create a favorite channel list so you can quickly browse through your favorite channels by pressing **FAVORITE**, then selecting a channel from the favorite channel list.

- 1 Press **MENU**.
- 2 Press \leftarrow or \rightarrow to highlight **Channels**, then press **ENTER**.

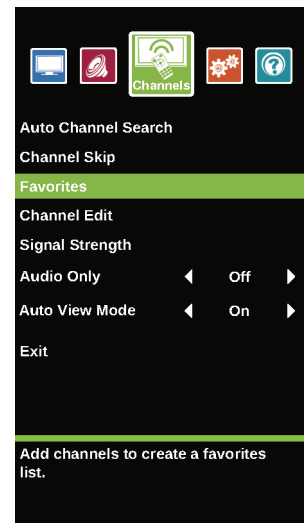

- 3 Press \blacktriangle or \blacktriangledown to highlight **Favorites**, then press **ENTER**.

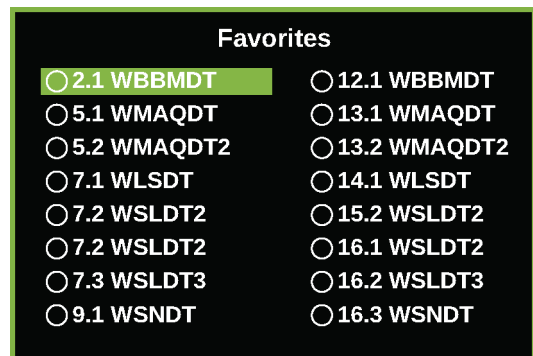

- Press **▲▼◀▶** to highlight the channel you want to add to the favorites list, then press **ENTER**. Each channel has a circle to the left. When you add a channel to the *Favorite List*, the circle is filled.

Notes

- If you highlight a channel in the list for two to four seconds, your TV displays the channel in the background.
- To remove a channel from the favorites list, highlight the channel, then press **ENTER**. The filled circle is replaced with an empty circle and the channel is removed from the list.
- If the list has more than one page, press **▲** or **▼** to scroll through the pages.

- Press **MENU** to return to the previous menu, or press **EXIT** to close the menu.

Viewing a favorite channel

- Press **FAVORITE**.
- Press **▲** or **▼** to highlight a channel, then press **ENTER**.

Adding or changing a channel label

If a channel is not already labeled, you can label the channel to make it easier to identify. You can also relabel a channel that is already labeled.

- Press **MENU**.
- Press **◀** or **▶** to highlight **Channels**, then press **ENTER**.

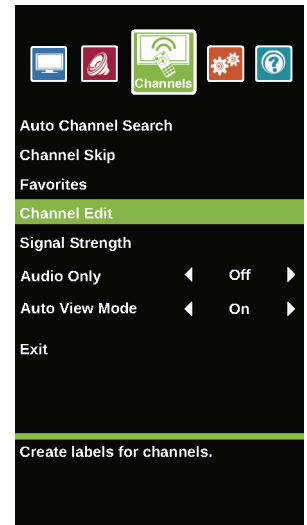

- Press **▲** or **▼** to highlight **Channel Edit**, then press **ENTER**.

- Press **◀** or **▶** to select the channel you want to label, then press **▼** to move to the channel label field.

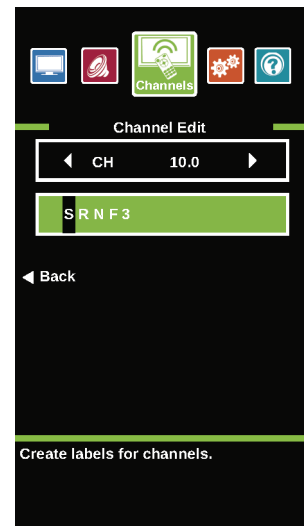

- Press **▲** or **▼** to select a character, then press **◀** or **▶** to move to the previous or next character position. Repeat this step to enter additional characters. You can enter as many as 11 characters.



- When you have completed the label, press **ENTER**.
- Press **EXIT** to close the menu.

Checking the digital signal strength

You can check the digital signal strength to determine if you need to adjust your antenna or digital cable input. The higher the signal strength, the less likely you are to experience picture degradation.

- Press **MENU**.
- Press **◀** or **▶** to highlight **Channels**, then press **ENTER**.

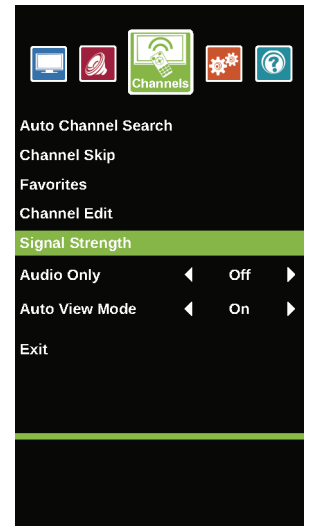

- Press **▲** or **▼** to highlight **Signal Strength**, then press **ENTER**.



- Press **MENU** to return to the previous menu, or press **EXIT** to close the menu.

Setting parental controls

Parental controls let you prevent your children from watching inappropriate material on TV. When set, parental controls read the rating of the program (with some exceptions, such as news and sports) and deny access to programs that exceed the ratings level you select. To watch programs that exceed the selected rating, you must enter a password.

Setting or changing the password

- 1 Press **MENU**.
- 2 Press ◀ or ▶ to highlight **Settings**, then press **ENTER**.

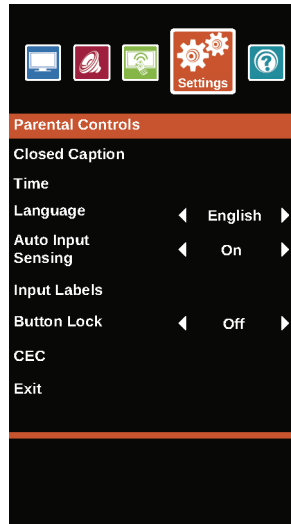

- 3 Press ▲ or ▼ to highlight **Parental Controls**, then press **ENTER**.

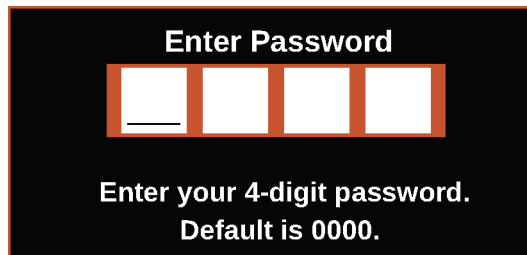

- 4 Press the number buttons to enter the four-digit password. The default password is **0000**. You should change the password to a number you can remember.

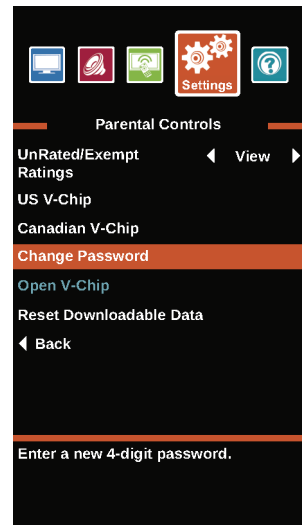

- 5 Press ▲ or ▼ to highlight **Change Password**, then press **ENTER**.

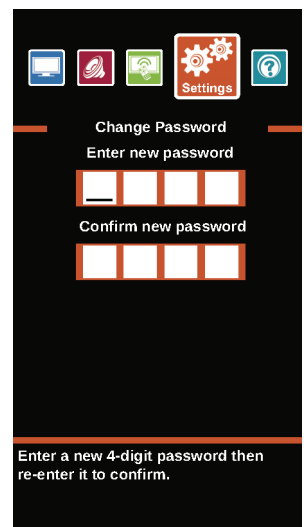

- 6 Press the number buttons to enter a password, then enter the password again. A message tells you that the password has been changed.

Note

If you forget your password, enter **9999**.

- 7 Press **MENU** to return to the previous menu, or press **EXIT** to close the menu.

Blocking unrated TV

Some TV programs, such as news and sports shows are not rated. When you set **UnRated/Exempt Ratings** to **Block**, TV programs that do not have ratings are blocked. When you try to watch a blocked program, you are prompted to enter the parental controls password.

- 1 Press **MENU**.
- 2 Press **◀** or **▶** to highlight **Settings**, then press **ENTER**.

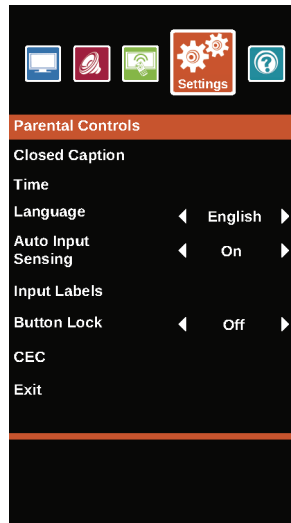

- 3 Press **▲** or **▼** to highlight **Parental Controls**, then press **ENTER**.



- 4 Press the number buttons to enter the four-digit password.

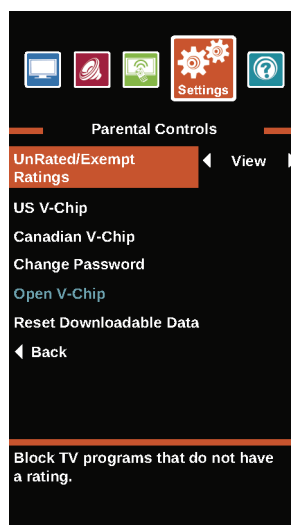

- 5 Press **▲** or **▼** to highlight **UnRated/Exempt Ratings**, then press **ENTER** or **▶** to access the option.
- 6 Press **◀** or **▶** to select **Block** (to block unrated TV) or **View** (to unblock unrated TV).
- 7 Press **MENU** to return to the previous menu, or press **EXIT** to close the menu.

Setting parental control levels

You can set parental controls for the U.S. and Canada.

U.S. rating levels

U.S. TV ratings	
NONE	Not rated
TV-Y	All children
TV-Y7	Suitable for children 7 and older
TV-G	General audiences
TV-PG	Parental guidance suggested
TV-14	Parental guidance strongly suggested
TV-MA	Mature audiences only

Some of the age-based TV Parental Guidelines ratings also have content-based ratings.

U.S. TV content ratings	
All	All ratings are blocked
FV	Fantasy violence
L	Strong language
S	Sexual situations
V	Violence
D	Suggestive dialog

U.S. movie (MPAA) ratings	
None	Movie not rated
G	General audiences
PG	Parental guidance suggested
PG-13	Suitable for children 13 and older
R	Parental guidance suggested for children under 17
NC-17	Not suitable for children under 17
X	Adults only

Canadian rating levels

Canadian English ratings	
E	Exempt programming
C	Suitable for all children
C8+	Suitable for children 8 and older
G	General audiences
PG	Parental guidance suggested
14+	Suitable for children 14 and older
18+	Adult only

Canadian French ratings	
E	Exempt programming
G	General audiences
8 ans+	Suitable for children 8 and older
13 ans+	Suitable for children 13 and older
16 ans+	Suitable for children 16 and older
18 ans+	Adult only

- 1 Press **MENU**.
- 2 Press **◀** or **▶** to highlight **Settings**, then press **ENTER**.

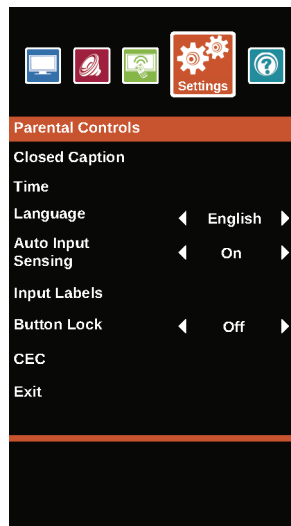

- 3 Press **▲** or **▼** to highlight **Parental Controls**, then press **ENTER**.

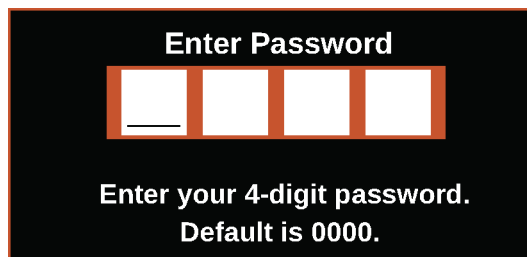

- 4 Press the number buttons to enter the four-digit password.

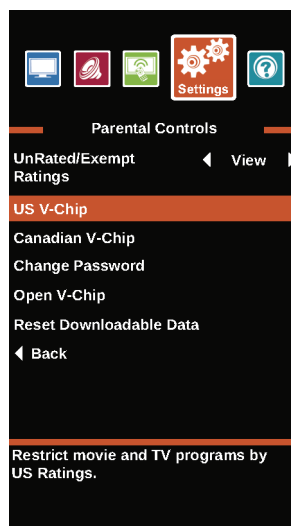

- 5 Press **▲** or **▼** to highlight **US V-Chip**, then press **ENTER**. (To set Canadian ratings, select **Canadian V-Chip**.)

US V-Chip

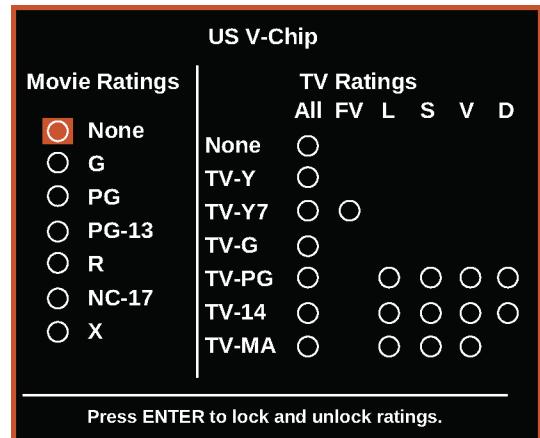

Canadian V-Chip

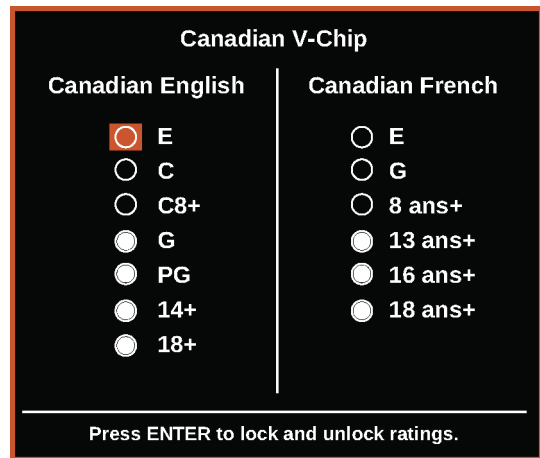

- 6 Press **◀** or **▶** to highlight:
 - **Movie Ratings** or **TV Ratings** for USA ratings.
 - **Canadian English** or **Canadian French** for Canadian ratings.
- 7 Press **▲** or **▼** to select the rating. If a rating has sub-ratings, press **◀** or **▶** to highlight a sub-rating.

Note

When you block a rating, that rating and all higher ratings are blocked.

- 8 Press **ENTER** to confirm. A filled circle appears when a rating is blocked. An empty circles appears when a rating is not blocked.
- 9 Press **MENU** to return to the previous menu, or press **EXIT** to close the menu.

Downloading rating information

If the program you are viewing has downloadable rating information, you can download the information to use when setting parental controls.

Note

If the program you are viewing does not have V-Chip rating information, **Open V-CHIP** is grayed on the *Settings - Parental Controls* menu and cannot be selected.

- 1 Press **MENU**.
- 2 Press **◀** or **▶** to highlight **Settings**, then press **ENTER**.

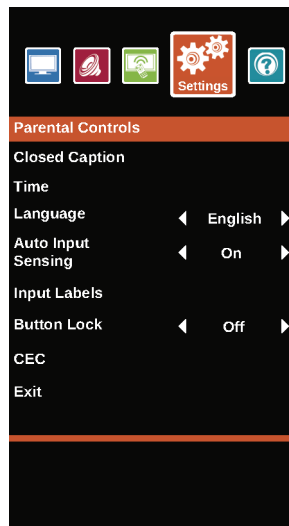

- 3 Press **▲** or **▼** to highlight **Parental Controls**, then press **ENTER**.

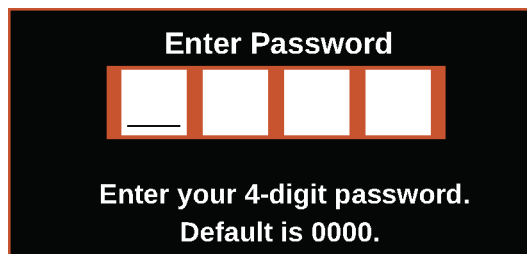

- 4 Press the number buttons to enter the four-digit password.

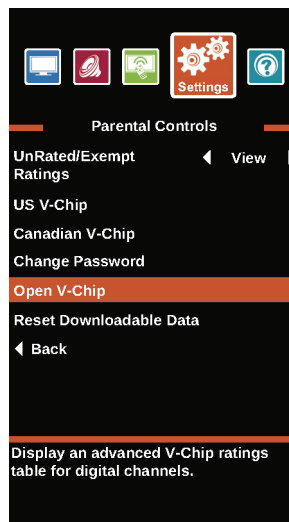

- 5 Press **▲** or **▼** to highlight **Open V-CHIP**, then press **ENTER**. The screen that you see may vary depending on the broadcaster.

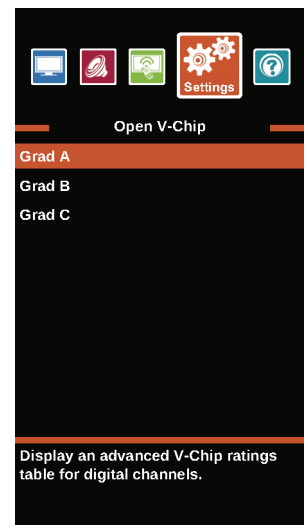

- 6 Press **▲▼◀▶** to select the program and content types you want to block, then press **ENTER**.

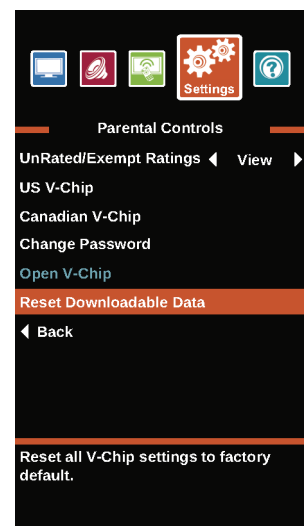

- 7 To reset the V-Chip information to the factory default, press **▲** or **▼** to highlight **Reset Downloadable Data**, then press **ENTER**. A box opens.
- 8 Press **▲** or **▼** to highlight **OK** or **Cancel**, then press **ENTER**.
- 9 Press **MENU** to return to the previous menu, or press **EXIT** to close the menu.

Locking the power button

When the button lock is turned **On**, the power button on the front of your TV is locked, and you can only operate your TV using the remote control.

- 1 Press **MENU**.
- 2 Press **◀** or **▶** to highlight **Settings**, then press **▼** or **ENTER**.

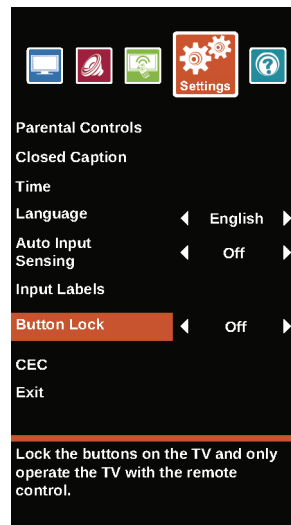

- 3 Press **▲** or **▼** to highlight **Button Lock**, then press **ENTER** or **▶** to access the option.
- 4 Press **◀** or **▶** to select **On** (locks the button) or **Off** (unlocks the button).
- 5 Press **MENU** to return to the previous menu, or press **EXIT** to close the menu.

Using closed captioning

Closed captioning displays a text version of the TV program audio or displays information provided by the broadcaster.

Turning closed captioning on or off

- 1 Press **MENU**.
- 2 Press **◀** or **▶** to highlight **Settings**, then press **ENTER**.

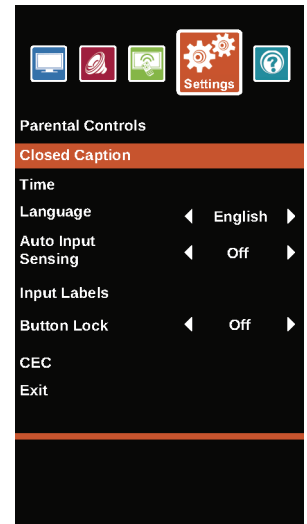

- 3 Press **▲** or **▼** to highlight **Closed Caption**, then press **ENTER**.

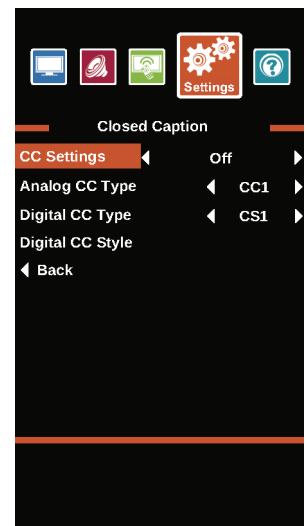

- 4 Press **▲** or **▼** to highlight **CC Settings**, then press **ENTER** or **▶** to access the option.
- 5 Press **◀** or **▶** to select **Off** (turns off closed captioning), **On Always** (turns on closed captioning), or **On When Mute** (turns on closed captioning when the sound is muted).
- 6 Press **MENU** to return to the previous menu, or press **EXIT** to close the menu.

Note

You can also press **CC** to turn closed captioning on or off.

Selecting the analog closed captioning mode

Analog channels usually have one or more closed captioning modes. The CC1 mode usually displays a text version of the TV program audio in a small banner. The other CC modes display information provided by the broadcaster. The Text modes display information in a box that covers half of the screen.

- 1 Press **MENU**.
- 2 Press **◀** or **▶** to highlight **Settings**, then press **ENTER**.

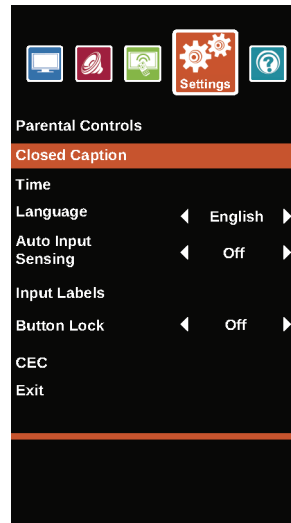

- 3 Press **▲** or **▼** to highlight **Closed Caption**, then press **ENTER**.

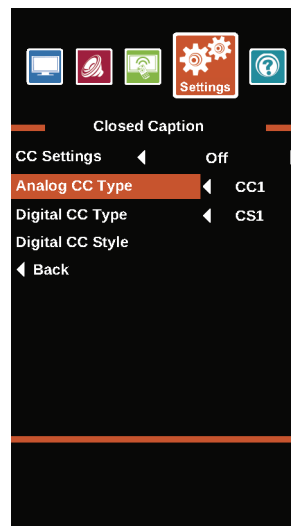

- 4 Press **▲** or **▼** to highlight **Analog CC Type**, then press **ENTER** or **▶** to access the option.
- 5 Press **◀** or **▶** to select an analog caption setting. You can select:
 - **CC1** through **CC4**—Closed captioning appears in a small banner across the bottom of the screen. **CC1** is usually the “printed” version of the audio. **CC2** through **CC4** display content provided by the broadcaster.
 - **Text1** through **Text4**—Closed captioning covers half or all of the screen. **Text1** through **Text4** display content provided by the broadcaster.
- 6 Press **MENU** to return to the previous menu, or press **EXIT** to close the menu.

Selecting the digital closed captioning mode

Digital channels usually have one or more closed captioning modes. The CS1 and CC1 modes usually display a text version of the TV program audio in a small banner. The other CS and CC modes display information provided by the broadcaster. CS1 mode displays a text version of the audio in the same language as the audio.

- 1 Press **MENU**.
- 2 Press **◀** or **▶** to highlight **Settings**, then press **ENTER**.

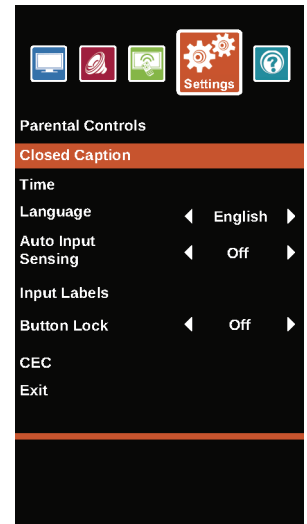

- 3 Press **▲** or **▼** to highlight **Closed Caption**, then press **ENTER**.

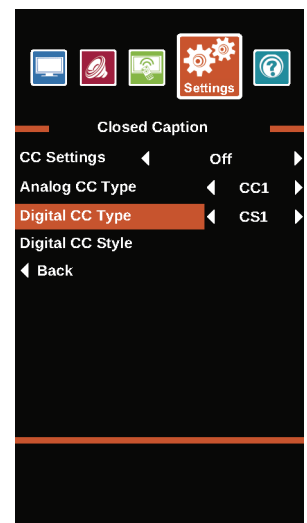

- 4 Press **▲** or **▼** to highlight **Digital CC Type**, then press **ENTER** or **▶** to access the menu.
- 5 Press **◀** or **▶** to select a digital caption setting. You can select:
 - **CS1** through **CS6**—**CS1** is usually the “printed” version of the audio. **CS2** through **CS6** display content provided by the broadcaster. You can change the way digital closed captioning is displayed on the screen. For more information, see “[Customizing digital closed captioning settings](#)” on page 55.
 - **CC1** through **CC4**—Closed captioning appears in a small banner across the bottom of the screen. **CC1** is usually the “printed” version of the audio. **CC2** through **CC4** display content provided by the broadcaster.
- 6 Press **MENU** to return to the previous menu, or press **EXIT** to close the menu.

Customizing digital closed captioning settings

- 1 Press **MENU**.
- 2 Press ◀ or ▶ to highlight **Settings**, then press **ENTER**.

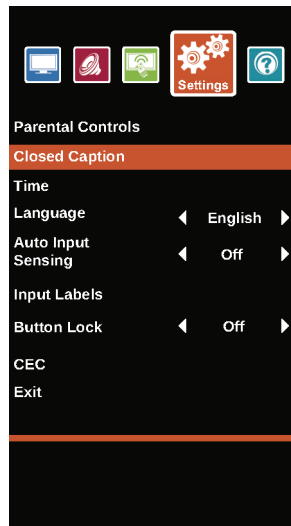

- 3 Press ▲ or ▼ to highlight **Closed Caption**, then press **ENTER**.

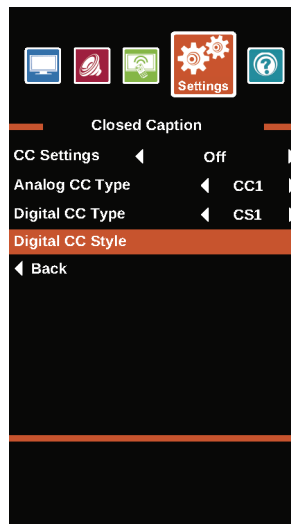

- 4 Press ▲ or ▼ to highlight **Digital CC Style**, then press **ENTER**.

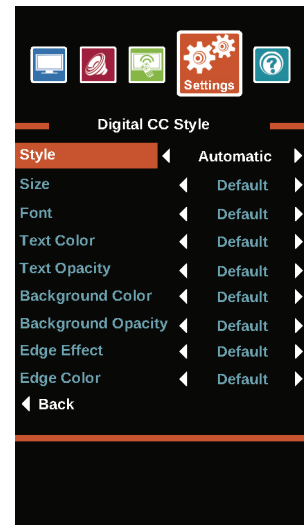

- 5 Press ▲ or ▼ to highlight **Style**, then press **ENTER** or ▶ to access the option.
- 6 Press ◀ or ▶ to highlight **Custom**, then press **ENTER**.
- 7 Press ▲ or ▼ to highlight an option, then press **ENTER** or ▶ to access the option. You can select:
 - **Size**—Selects the font size.
 - **Font**—Selects the font style.
 - **Text Color**—Selects the color for the words.
 - **Text Opacity**—Selects the opacity level for the words.
 - **Background Color**—Selects the color for the background.
 - **Background Opacity**—Selects the opacity level for the background.
 - **Edge Effect**—Selects the style of the letter edges.
 - **Edge Color**—Selects the color of the letter edges.
- 8 Press ◀ or ▶ to select a setting, then press **ENTER**. Press ◀ or ▶ to adjust the setting.
- 9 Press **MENU** to return to the previous menu, or press **EXIT** to close the menu.

Adjusting time settings

When you set up your TV for the first time, you set up the clock. If the power is disconnected or you move your TV to a different time zone, you need to reset the clock to the correct time.

Setting the clock

- 1 Press **MENU**.
- 2 Press **◀** or **▶** to highlight **Settings**, then press **ENTER**.

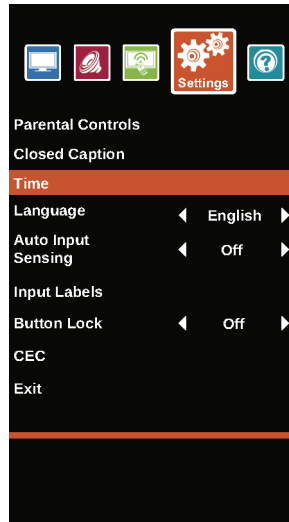

- 3 Press **▲** or **▼** to highlight **Time**, then press **ENTER**.

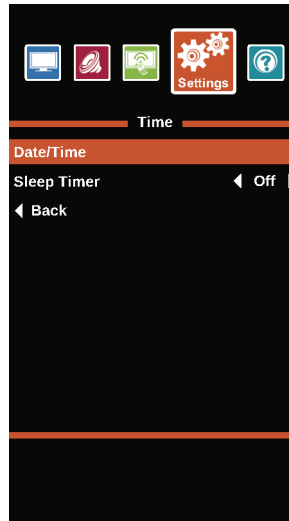

- 4 Press **▲** or **▼** to highlight **Date/Time**, then press **ENTER**.

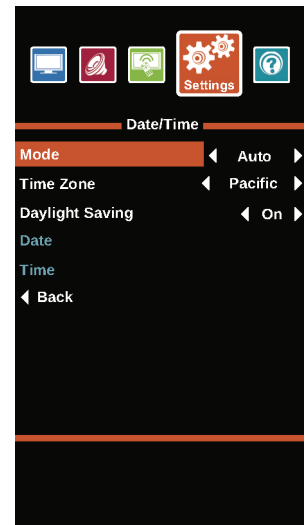

- 5 Press **▲** or **▼** to highlight **Mode**, then press **ENTER** or **▶** to access the option.
- 6 Press **◀** or **▶** to highlight **Manual** (to set the options manually) or **Auto** (the options are automatically set by the TV signal source), then press **ENTER**.
- 7 Press **▲** or **▼** to highlight **Time Zone**, then press **ENTER** or **▶** to access the option.
- 8 Press **◀** or **▶** to select your time zone, then press **ENTER**. You can select **Eastern, Central, Mountain, Pacific, Alaska, Hawaii, Atlantic, or Newfoundland**.
- 9 If your viewing area observes Daylight Saving Time, press **▲** or **▼** to highlight **Daylight Saving**, then press **ENTER** or **▶** to access the option.
- 10 Press **◀** or **▶** to select **On** or **Off**, then press **ENTER**.
- 11 Press **▲** or **▼** to highlight **Date**, then press **ENTER**.
- 12 Press **◀**, **▶** or **ENTER** to highlight **Month, Day, or Year**, then press **▲** or **▼** to adjust the setting. When you are finished, use the arrow buttons to highlight **Back**, then press **ENTER**.
- 13 Press **▲** or **▼** to highlight **Time**, then press **ENTER**.
- 14 Press **◀**, **▶** or **ENTER** to highlight the **Hour, Minute, or AM/PM** field, then press **▲** or **▼** to adjust the setting. When you are finished, use the arrow buttons to highlight **Back**, then press **ENTER**.
- 15 Press **MENU** to return to the previous menu, or press **EXIT** to close the menu.

Setting the sleep timer

You can specify the amount of time before your TV automatically turns off.

- 1 Press **MENU**.
- 2 Press **◀** or **▶** to highlight **Settings**, then press **ENTER**.

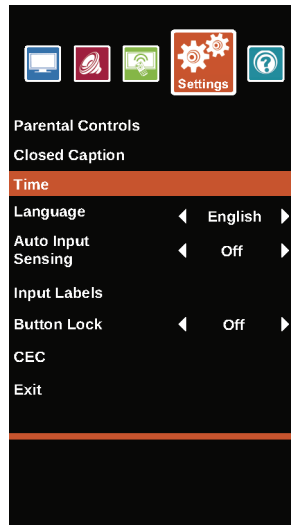

- 3 Press **▲** or **▼** to highlight **Time**, then press **ENTER**.

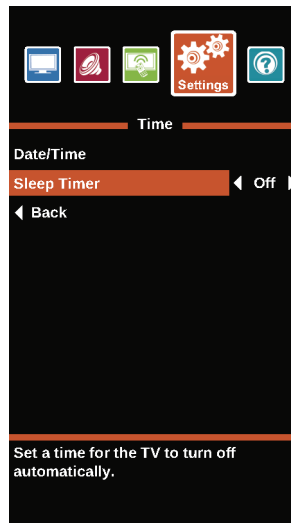

- 4 Press **▲** or **▼** to highlight **Sleep Timer**, then press **ENTER** or **▶** to access the option.
- 5 Press **◀** or **▶** to select the amount of time before your TV turns off automatically. You can select **Off**, **5 minutes**, **10 minutes**, **15 minutes**, **30 minutes**, **60 minutes**, **90 minutes**, **120 minutes**, **180 minutes**, or **240 minutes**.
To turn off the sleep timer, select **Off**.
- 6 Press **MENU** to return to the previous menu, or press **EXIT** to close the menu.

Note

You can also press **SLEEP** to set the sleep timer.

Adjusting menu settings

Selecting the menu language

Your TV can display the on-screen menu in English, French, or Spanish. When you set your TV up for the first time, you select the language. You can change the menu language to a different language.

- 1 Press **MENU**.
- 2 Press **◀** or **▶** to highlight **Settings**, then press **ENTER**.

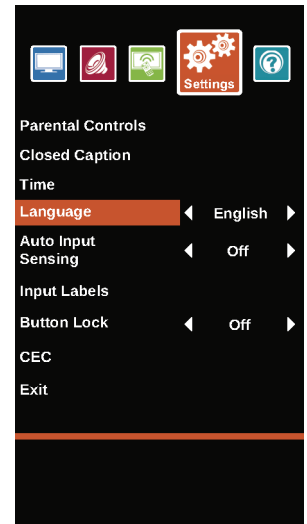

- 3 Press **▲** or **▼** to highlight **Language**, then press **ENTER** or **▶** to access the option.
- 4 Press **◀** or **▶** to highlight a language, then press **ENTER**. You can select **English**, **Français**, or **Español**.
- 5 Press **MENU** to return to the previous menu, or press **EXIT** to close the menu.

Turning Input Sensor on or off

When the Input Sensor feature is turned on, your TV automatically detects which video jacks have devices connected to them. Your TV uses this information to determine what options you can select on the *INPUT SOURCE* list when you press **INPUT**.

- 1 Press **MENU**.
- 2 Press ◀ or ▶ to highlight **Settings**, then press **ENTER**.

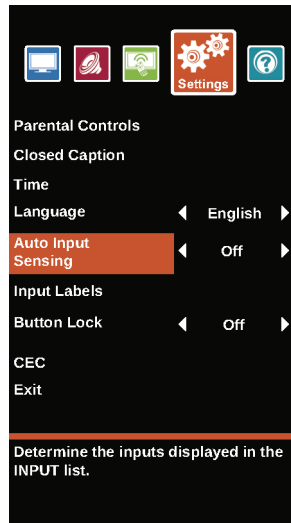

- 3 Press ▲ or ▼ to highlight **Auto Input Sensing**, then press **ENTER** or ▶ to access the option.
- 4 Press ◀ or ▶ to select **On** (turns on the input sensor) or **Off** (turns off the input sensor).
- 5 Press **MENU** to return to the previous menu, or press **EXIT** to close the menu.

Labeling an input source

You can add a label to an input source to make it easier to identify in the *INPUT SOURCE* list.

- 1 Press **MENU**.
- 2 Press ◀ or ▶ to highlight **Settings**, then press **ENTER**.

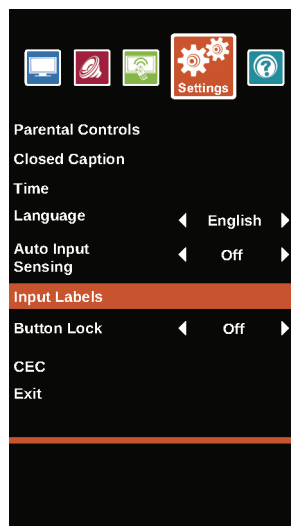

- 3 Press ▲ or ▼ to highlight **Input Labels**, then press **ENTER** or ▶ to access the option.

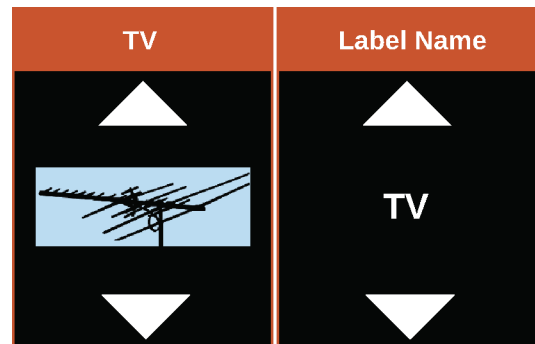

- 4 Press ▲ or ▼ to select the input source you want to label, then press ▶ to move to the label field.

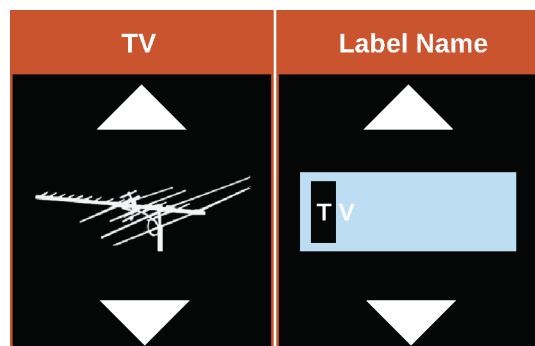

- 5 Press ▲ or ▼ to highlight a preset label or **Custom**.
- 6 If you select a preset label, press **ENTER**. The input source box on the left is selected so you can label a different input source.

OR

If you select **Custom**, press **ENTER**, press ▲ or ▼ to enter the first character in your custom label, then press ▶ to move to the next character position. Use the arrow buttons to enter additional characters or to move from character to character. You can enter 12 characters (letters or numbers). When you have finished creating your label, press **ENTER**. The input source box on the left is selected so you can label a different input source. The next time you press **INPUT**, your label appears in the *INPUT SOURCE* list.

- 7 Press **EXIT** to close the menu.

Maintenance

- Do not use your TV in areas that are too hot or too cold, because the cabinet may warp or the screen may malfunction. Your TV works best in temperatures that are comfortable to you.
- Storage temperatures are 32° to 122°F (0° to 50°C).
- Working temperatures are 41° to 104°F (5° to 40°C).
- Do not place your TV in direct sunlight or near a heat source.

Cleaning the TV cabinet

Clean the cabinet with a soft, lint-free cloth. If the cabinet is especially dirty, moisten a soft, lint-free cloth in a weak detergent solution, squeeze the excess moisture from the cloth, then wipe the cabinet with the cloth. Use a clean cloth to dry the cabinet.

Cleaning the TV screen

Clean the screen with a soft, lint-free cloth.

Troubleshooting

Warning

Do not try to repair your TV yourself.
Contact authorized service personnel.

Viewing system information

You may need to view system information during troubleshooting.

- 1 Press **MENU**.
- 2 Press **◀** or **▶** to highlight **HELP**, then press **ENTER**.

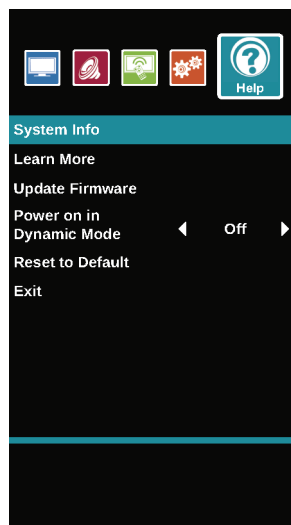

- 3 Press **▲** or **▼** to highlight **System Info**, then press **ENTER**. Information about the TV software version is displayed.
- 4 If your TV uses open source software, press **ENTER** to view the *Open Source Software Notice*.
- 5 Press **MENU** to return to the previous menu, or press **EXIT** to close the menu.

Learning more

You can learn more about remote control codes and connecting a sound bar.

- 1 Press **MENU**.
- 2 Press **◀** or **▶** to highlight **HELP**, then press **ENTER**.

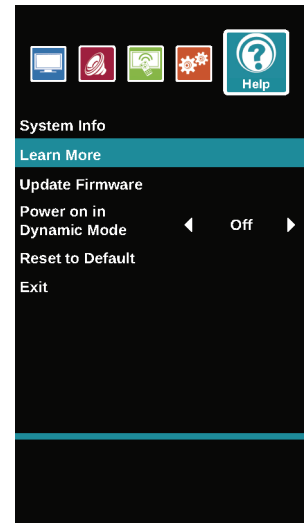

- 3 Press **▲** or **▼** to highlight **Learn More**, then press **ENTER**.

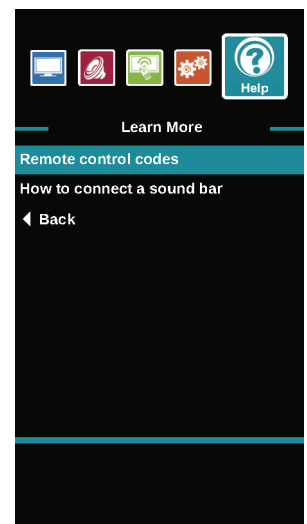

- 4 Press **▲** or **▼** to highlight a topic, then press **ENTER**. Your TV displays information about the topic you selected.
- 5 Press **MENU** to return to the previous menu, or press **EXIT** to close the menu.

Updating the TV firmware

If your TV is behaving oddly and you have tried all the solutions in the troubleshooting pages, you may need to update the TV firmware.

Cautions

- Make sure that you have tried all other solutions before you upgrade the firmware.
- While the firmware is updating, do not turn off your TV.

Note

To update the TV firmware, you need a:

- Computer with an available USB port
- High-speed Internet connection
- USB flash drive

- 1 On the *Help* menu, select **System Info**, then write down your model, revision, and firmware information. See “[Viewing system information](#)” on page 59.
- 2 Go to <https://www.sharptvusa.com/support>
- 3 Under *Search by Model Number*, enter **LC-40LB480U**, then press **ENTER**.
- 4 Click **FIRMWARE**. If available, the most current firmware version is listed.
- 5 Download the firmware update and copy it to a USB flash drive.
- 6 Plug the USB flash drive into the USB port on the side of your TV. A message asks if you want to update the firmware.
- 7 Highlight **Yes**, then press **ENTER**.
- 8 Follow the on-screen instructions to install the update. **Do not turn off your TV until the update is complete.**
- 9 When the update is complete, unplug the USB flash drive, then press **ENTER**. Your TV turns off then on to complete the update.
- 10 If the channel list has been deleted, you need to scan for channels. For more information, see “[Automatically scanning for channels](#)” on page 45.

Note

- If you see a message that says the firmware file is incorrect, make sure that you have downloaded the correct file for your model.
- If you see a message that says the update failed or the TV screen is blank and the power LED is blinking red then blue, turn off your TV, turn it back on, then run the upgrade again.

Restoring settings to the defaults

When you restore default settings, all the settings you have customized (except parental controls) are reset.

- 1 Press **MENU**.
- 2 Press ◀ or ▶ to highlight **HELP**, then press **ENTER**.

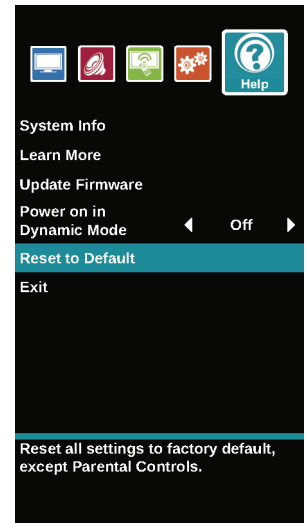

- 3 Press ▲ or ▼ to highlight **Reset to Default**. A message asks if you want to reset all TV settings to the default settings.
- 4 Press ▲ or ▼ to select **OK** (to reset) or **Cancel** (to not reset), then press **ENTER**.
If you select **OK**, your TV restarts and the *Easy Setup* wizard opens.
- 5 Go through the *Easy Setup* wizard. For more information, see “[Turning on your TV for the first time](#)” on page 30.

Video and audio

Problem	Solution
Picture does not fill the screen. There are black bars around the picture.	<ul style="list-style-type: none"> Change the aspect ratio. An increasing amount of digital TV and movies are presented in wide screen (16:9). See the View Mode option in "Adjusting the TV picture" on page 40.
No picture (screen is not lit) and no sound.	<ul style="list-style-type: none"> Press  on the TV or the remote control. Make sure that the Audio Only option is set to Off. See "Playing TV audio only" on page 44. Make sure that the video cables are connected securely to your TV. Adjust the contrast and brightness. See "Adjusting the TV picture" on page 40. Make sure that the power cord is plugged in. Make sure that the correct video input source is selected. See "Selecting the video input source" on page 32. Try another channel. The station may be experiencing problems. Make sure that the incoming signal is compatible. Make sure that the antenna or cable TV is connected correctly and securely. See "Connecting a cable or satellite box" on page 13 or "Connecting an antenna or cable TV (no box)" on page 16. Check the closed caption settings. Some TEXT modes can block the screen.

Problem	Solution
Dark, poor, or no picture (screen is lit), but sound is good.	<ul style="list-style-type: none"> Try another channel. The station may be experiencing problems. Make sure that the antenna or cable TV is connected correctly and securely. See "Connecting a cable or satellite box" on page 13 or "Connecting an antenna or cable TV (no box)" on page 16. Adjust the brightness. See "Adjusting the TV picture" on page 40. Make sure that the correct picture mode is selected. See "Adjusting the TV picture" on page 40. If you are using an antenna, the digital channel signal may be low. To check the digital channel signal strength, see "Checking the digital signal strength" on page 48. If you are using an antenna and the signal strength is low, adjust the antenna or use a highly directional outdoor antenna or set-top antenna with a built-in amplifier. Make sure that the video cables are connected securely to your TV. The video cable(s) you are using may be bad. Try a new set. Try another channel. The station may be experiencing problems.
No color, dark picture, or color is not correct.	<ul style="list-style-type: none"> Try another channel. The station may be experiencing problems. Adjust the color settings. See "Adjusting the TV picture" on page 40. Make sure that the video cables are connected correctly and securely to your TV. Make sure that the antenna or cable TV is connected correctly and securely. See "Connecting a cable or satellite box" on page 13 or "Connecting an antenna or cable TV (no box)" on page 16. If you are using an antenna, the digital channel signal may be low. To check the digital channel signal strength, see "Checking the digital signal strength" on page 48. If you are using an antenna and the signal strength is low, adjust the antenna or use a highly directional outdoor antenna or set-top antenna with a built-in amplifier.

Problem	Solution
Only snow (noise) appears on the screen.	<ul style="list-style-type: none"> • Try another channel. The station may be experiencing problems. • Make sure that the antenna or cable TV is connected correctly and securely. See “Connecting a cable or satellite box” on page 13 or “Connecting an antenna or cable TV (no box)” on page 16. • If you are using an antenna, the digital channel signal may be low. To check the digital channel signal strength, see “Checking the digital signal strength” on page 48. • If you are using an antenna and the signal strength is low, adjust the antenna or use a highly directional outdoor antenna or set-top antenna with a built-in amplifier.
Picture quality is good on some channels and poor on others. Sound is good.	<ul style="list-style-type: none"> • The problem may be caused by a poor or weak signal from the broadcaster or cable TV provider. • If you connect to cable or satellite TV without a set-top box and experience poor picture quality, you may need to install a set-top box to improve signal reception and picture quality. Contact your cable or satellite TV provider about upgrading to a set-top box.

Problem	Solution
Dotted lines or stripes appear on the screen.	<ul style="list-style-type: none"> • Make sure that the antenna or cable TV is connected correctly and securely. See “Connecting a cable or satellite box” on page 13 or “Connecting an antenna or cable TV (no box)” on page 16. • If you are using an antenna, the digital channel signal may be low. To check the digital channel signal strength, see “Checking the digital signal strength” on page 48. • If you are using an antenna and the signal strength is low, adjust the antenna or use a highly directional outdoor antenna or set-top antenna with a built-in amplifier. • Make sure that the video cables are connected securely to your TV. • The video cable(s) you are using may be bad. Try a new set. • Other devices (for example, a surround sound receiver, external speakers, fans, or hair dryers) may be interfering with your TV. Try turning off one device at a time to determine which device is causing interference. After you have determined which device is causing interference, move it further from the TV to eliminate the interference.
Double images.	<ul style="list-style-type: none"> • Use a highly directional outdoor antenna, cable TV, or satellite TV.
The picture has a few bright or dark spots.	<ul style="list-style-type: none"> • A few bright or dark spots on an LCD screen is normal. It does not affect the operation of your TV.

Problem	Solution
Good picture, but no sound.	<ul style="list-style-type: none"> • Increase the volume. • Make sure that the sound is not muted. • Make sure that you do not have headphones connected. When headphones are connected, no sound comes from the TV speakers. • Make sure that the correct audio mode is selected. • Make sure that the audio cables are connected correctly and securely to your TV. • Make sure that the antenna or cable TV is connected correctly and securely. See “Connecting a cable or satellite box” on page 13 or “Connecting an antenna or cable TV (no box)” on page 16. • If you are using an antenna, the digital channel signal may be low. To check the digital channel signal strength, see “Checking the digital signal strength” on page 48. • The audio cable(s) you are using may be bad. Try a new set.
Poor picture.	<ul style="list-style-type: none"> • Make sure that the room is not too bright. Light reflecting off the screen can make the picture difficult to see. • If an S-VHS camera or a camcorder is connected while another connected device is turned on, the picture may be poor. Turn off one or more devices.
Good sound, but poor color.	<ul style="list-style-type: none"> • Adjust the contrast, color, and brightness settings. See “Adjusting the TV picture” on page 40.
Audio noise.	<ul style="list-style-type: none"> • Other devices (for example, a surround sound receiver, external speakers, fans, or hair dryers) may be interfering with your TV. Try turning off one device at a time to determine which device is causing interference. After you have determined which device is causing interference, move it further from the TV to eliminate the interference.

Problem	Solution
No output from one of the speakers.	<ul style="list-style-type: none"> • Adjust the audio balance. See “Adjusting sound settings” on page 43. • Make sure that the audio cables are connected correctly and securely to your TV.
After images appear.	<ul style="list-style-type: none"> • Do not display a still image, such as a logo, game, or computer image, for an extended period of time. This can cause a permanent after-image to be burned into the screen. This type of damage is not covered by your warranty.

Remote control

Problem	Solution
Remote control does not work.	<ul style="list-style-type: none"> • Make sure that the power cord is correctly connected to your TV and a power outlet. • Make sure that there are no obstructions between the remote control and the remote control sensor on the front of the TV. • Point the remote control directly at the remote control sensor on your TV. For the location of the remote control sensor, see “Front” on page 8. • The supplied batteries are wrapped tightly in clear plastic. Make sure that you have removed this plastic from the batteries. • Make sure that the batteries are installed correctly. See “Installing remote control batteries” on page 28. • Replace dead batteries with new batteries. See “Installing remote control batteries” on page 28.

General

Problem	Solution
No power.	<ul style="list-style-type: none"> • Make sure that the power cord is correctly connected to your TV and a power outlet. • Unplug the power cord, wait 60 seconds, then plug the cord back in and turn on your TV. • Other devices (for example, a surround sound receiver, external speakers, fans, or hair dryers) may be interfering with your TV. Try turning off one device at a time to determine which device is causing interference. After you have determined which device is causing interference, move it further from the TV to eliminate the interference.

Problem	Solution
"No signal" error message is displayed.	<ul style="list-style-type: none"> Press INPUT and make sure that you have selected the correct input for the device or service you are trying to use. If you are using a cable or satellite box, make sure that it is plugged in and turned on. If you are using a cable or satellite box, use the remote that came with that box to change channels. Make sure that you have the correct input selected to view channels from the cable or satellite box.
After Auto Channel Search, there are no channels.	<ul style="list-style-type: none"> Reception can vary by channel depending on the broadcast power level of a given station. Contact your cable or satellite TV provider. Make sure that the antenna or cable/satellite TV is connected securely to your TV. Try replacing the cable between the antenna/cable or cable/satellite box and your TV.
One or more channels do not display.	<ul style="list-style-type: none"> Make sure that the channels are not blocked. See "Setting parental control levels" on page 50. Make sure that the channels are not hidden. The channel may have been deleted from the channel list. You can tune to the channel by pressing the number buttons or you can add the channel back to the channel list. See "Hiding channels" on page 46. If you are using a cable or satellite box, use the remote that came with that box to change channels. Make sure that you have the correct input selected to view channels from the cable or satellite box. If you are using an antenna, the digital channel signal may be low. To check the digital channel signal strength, see "Checking the digital signal strength" on page 48.
Password is lost.	<ul style="list-style-type: none"> Enter 9999 to access parental controls, then set a new password. See "Setting or changing the password" on page 49.
Some settings cannot be accessed.	<ul style="list-style-type: none"> If a setting is grayed, the setting is not available in the current video input mode.

Problem	Solution
TV cabinet creaks.	<ul style="list-style-type: none"> When the TV is in use, the temperature rises naturally and may cause the cabinet to expand or contract which can cause a creaking noise. This is not a malfunction.
The ⏻/INPUT does not work.	<ul style="list-style-type: none"> Make sure that the Button Lock option is set to Off. See "Locking the power button" on page 53. Unplug the power cord, wait a few seconds, then plug the cord back in and turn on your TV.
TV keeps turning off.	<ul style="list-style-type: none"> Make sure that the sleep timer is not turned on. See "Setting the sleep timer" on page 57.
A retail banner is displayed.	<ul style="list-style-type: none"> You selected "Store" mode when you ran the EASY SETUP wizard. Reset your TV to the factory defaults, then select Home on the <i>What is your viewing environment</i> screen. See "Restoring settings to the defaults" on page 60.

CEC-compatible device

Problem	Solution
My TV is not displaying the video from the connected CEC device.	<ul style="list-style-type: none"> Make sure that the HDMI cable is connected securely to your TV and the device. Make sure that the device is connected to your TV with an HDMI cable. Make sure that the device is a CEC-compatible device. See the documentation that came with the device for more information. Make sure that the correct video input source is selected. See "Selecting the video input source" on page 32. Make sure that the CEC Control feature is turned on. See "Turning CEC Control on or off" on page 35. Try adjusting the TV picture. See "Adjusting the TV picture" on page 40. If the device is not a Sharp device, it may not be compatible with your TV.

Problem	Solution
My TV is not playing the audio from the connected CEC device.	<ul style="list-style-type: none"> • Make sure that the HDMI cable is connected securely to your TV and the device. • Make sure that the device is connected to your TV with an HDMI cable. • Make sure that the device is a CEC-compatible device. See the documentation that came with the device. • Make sure that the TV volume is turned up and not muted. • Try adjusting the TV sound. See “Adjusting sound settings” on page 43. • Make sure that the TV speakers are turned on and not muted. See “Adjusting sound settings” on page 43. • Make sure that the CEC control feature is turned on. See “Turning CEC Control on or off” on page 35. • If you have connected an HDMI CEC audio receiver, adjust the volume on the receiver. When your TV detects an audio receiver, the TV speakers turn off and sound plays through receiver speakers only.
My TV's remote control does not control the device.	<ul style="list-style-type: none"> • Make sure that there are no obstructions between the remote control and the remote control sensors on your TV and the device. • If the device is not a Sharp device, all the buttons may not work. • Make sure that the CEC Control feature is turned on. See “Turning CEC Control on or off” on page 35. • If you are trying to control the volume on an HDMI CEC audio receiver using your TV remote control, make sure that the Audio Return Channel option on the CEC menu is set to On. See “Turning Audio Return Channel on or off” on page 36. • The device may not support this feature. See the documentation that came with the device for more information.

Problem	Solution
The device does not show up in the CEC Device list.	<ul style="list-style-type: none"> • Make sure that the device is turned on. • Make sure that the HDMI cable is connected securely to your TV and the device. • Make sure that the device is connected to your TV with an HDMI cable. • Make sure that the CEC Control feature is turned on. See “Turning CEC Control on or off” on page 35. • Make sure that the device is a CEC-compatible device. See the documentation that came with the device. • If the device is not a Sharp device, it may not be compatible with your TV.
My device does not turn off when I turn off my TV.	<ul style="list-style-type: none"> • Make sure that the CEC Control feature is turned on. See “Turning CEC Control on or off” on page 35. • Make sure that Device Auto Power Off is set to On on the CEC menu. See “Turning Device Auto Power Off on or off” on page 35. • The device may not support this feature. See the documentation that came with the device for more information.
My TV does not turn on when I turn on my device.	<ul style="list-style-type: none"> • Make sure that the CEC Control feature is turned on. See “Turning CEC Control on or off” on page 35. • Make sure that TV Auto Power On is set to On on the CEC menu. See “Turning TV Auto Power On on or off” on page 36. • The device may not support this feature. See the documentation that came with the device for more information.

Problem	Solution
<p>The Audio Return Channel setting on the CEC menu keeps turning back on after it is turned off.</p>	<ul style="list-style-type: none"> When Audio Return Channel is set to Off and CEC Control is set to On and you adjust the volume on the audio receiver, Audio Return Channel is automatically set to On. To prevent this from happening, turn off the CEC Control feature. See "Turning CEC Control on or off" on page 35.

Problem	Solution
<p>I cannot select the Root Menu option on the CEC menu. OR The device's root menu does not open when I select Root Menu on the CEC menu.</p>	<ul style="list-style-type: none"> The device may not support this feature. See the documentation that came with the device for more information.

Note

If the problem is not solved by using these troubleshooting instructions, turn off your TV, then turn it on again.

Specifications

Specifications are subject to change without notice.

Dimensions and weight

Without stand (H × W × D)	21.1 × 36.1 × 3.5 in. (53.7 × 91.7 × 9 cm) 16.3 lbs (7.4 kg)
With stand H × W × D	22.6 × 36.1 × 8.1 in. (57.3 × 91.7 × 20.6 cm) 16.8 lbs (7.6 kg)

Screen

Screen size measured diagonally	40 in. (101.6 cm)
Panel	LCD
Panel backlight type	LED
Panel 60 Hz vs. 120 Hz	60Hz
Display resolution	1080p
Panel resolution	1920 (H) × 1080 (V)
Aspect ratio	16:9
Contrast ratio (typical)–panel	4,000:1
TV Brightness (minimum) cd/m ²	200 nits
Comb filter	3d y/c digital
Response time	8 ms
Horizontal viewing angle	178°
Vertical viewing angle	178°

Display resolutions

HDMI suggested resolutions	1080p, 1080i, 720p, 480p, 480i
----------------------------	--------------------------------

Tuner

Analog	NTSC
Digital	ATSC, 8-VSB, Clear-QAM

Inputs

HDMI	3 (side) EDID compliant HDCP compliant
Component video	No
Composite video	1 (side)
PC/VGA	No
3.5mm PC audio input	No
USB	1 (side) Supports JPEG
Antenna/Cable	1 (side)

Outputs

Video	No
Analog audio/Headphone	1 (side)
Digital audio	1 (optical) (side)
WiFi	No
Ethernet	No

Audio

DTS Tuning Packag	DTS TruSurround
Speakers	Number: 2 Watts per channel: 8W

Power

Power consumption	On: 75W Standby: <0.5W
Power input	AC 120 V, 60Hz

Miscellaneous

OSD languages	English, French, Spanish
ENERGY STAR qualified	No
Internet connectable	No
TV base screws	M4 type (20 mm length) (4 pcs)
V-Chip (version 2.0)	Yes
Sleep timer	Yes
Channel labeling	Yes
VESA mount (mm) (horizontal × vertical)	200 × 200
VESA mount screws	M6 type

Note

The length of the wall-mount screws vary depending on the wall-mount bracket you purchased. See the instructions that came with the wall-mount bracket for screw lengths.

Legal notices

FCC Statement

This device complies with Part 15 of the FCC Rules. Operation is subject to the following two conditions: (1) this device may not cause harmful interference, and (2) this device must accept any interference received, including interference that may cause undesired operation.

This equipment has been tested and found to comply with the limits for a Class B digital device, pursuant to Part 15 of the FCC Rules. These limits are designed to provide reasonable protection against harmful interference in a residential installation. This equipment generates, uses and can radiate radio frequency energy and, if not installed and used in accordance with the instructions, may cause harmful interference to radio communications. However, there is no guarantee that interference will not occur in a particular installation. If this equipment does cause harmful interference to radio or television reception, which can be determined by turning the equipment off and on, the user is encouraged to try to correct the interference by one or more of the following measures:

- Reorient or relocate the receiving antenna.
- Increase the separation between the equipment and receiver.
- Connect the equipment into an outlet on a circuit different from that to which the receiver is connected.
- Consult the dealer or an experienced radio/TV technician for help.

Warning

Changes or modifications not expressly approved by the party responsible for compliance could void the user's authority to operate the equipment.

Cables

Connections to this device must be made with shielded cables with metallic RF/EMI connector hoods to maintain compliance with FCC Rules and Regulations.

IC Statement

This device complies with Industry Canada licence-exempt RSS standard(s).

Operation is subject to the following two conditions: (1) this device may not cause interference, and (2) this device must accept any interference, including interference that may cause undesired operation of the device.

This equipment complies with IC radiation exposure limits set forth for an uncontrolled environment.

Dolby License Notice and Trademark Acknowledgement

 **DOLBY AUDIO™** Manufactured under license from Dolby Laboratories. Dolby, Dolby Audio, and the double-D symbol are trademarks of Dolby Laboratories.

HDMI

 **HDMI®** HIGH-DEFINITION MULTIMEDIA INTERFACE The terms HDMI and HDMI High-Definition Multimedia Interface, and the HDMI Logo are trademarks or registered trademarks of HDMI Licensing LLC in the United States and other countries.

DTS TruSurround™

 **dts®** TruSurround For DTS patents, see <http://patents.dts.com>. Manufactured under license from DTS Licensing Limited. DTS, the Symbol, & DTS and the Symbol together are registered trademarks and DTS TruSurround is a trademark of DTS, Inc. © DTS, Inc. All Rights Reserved.

One-year limited warranty - Sharp Televisions

Definitions:

Best Buy ("Warrantor") warrants to you, the original purchaser of this new Sharp-branded television ("Product"), that the Product shall be free of defects in the original manufacturer of the material or workmanship for a period of one (1) year from the date of your purchase of the Product ("Warranty Period"). For this warranty to apply, your Product must be purchased in the United States or Canada from a Best Buy authorized dealer of Sharp brand products only that are packaged with this warranty statement.

How long does the coverage last?

The Warranty Period lasts for 1 year (365 days) from the date you purchased the Product. Your purchase date is printed on the receipt you received with the Product.

What does this warranty cover?

During the Warranty Period, if the original manufacture of the material or workmanship of the Product is determined to be defective by an authorized Warrantor repair center or store personnel, Warrantor will (at its sole option): (1) repair the Product with new or rebuilt parts; or (2) replace the Product at no charge with new or rebuilt comparable products or parts. Products and parts replaced under this warranty become the property of Warrantor and are not returned to you. If service of Products or parts are required after the Warranty Period expires, you must pay all labor and parts charges. This warranty lasts as long as you own your Sharp Product during the Warranty Period. Warranty coverage terminates if you sell or otherwise transfer the Product.

How to obtain warranty service?

If you purchased the Product at a Best Buy retail store location and your television Product has a screen size of less than 42 inches, please take your original receipt and the Product to any Best Buy store. Make sure that you place the Product in its original packaging or packaging that provides the same amount of protection as the original packaging. If you purchased the Product from a Best Buy online web site, mail your original receipt and the Product to the address listed on the web site. Make sure that you put the Product in its original packaging or packaging that provides the same amount of protection as the original packaging.

To obtain in-home warranty service for a television with a screen 42 inches or larger, in the United States call 1-888-BESTBUY or Canada call 1-866-BESTBUY. Call agents will diagnose and correct the issue over the phone or will have an Sharp-approved repair technician dispatched to your home.

Where is the warranty valid?

This warranty is valid only in the United States and Canada at Best Buy branded retail stores or websites to the original purchaser of the product in the county where the original purchase was made.

What does the warranty not cover?

This warranty does not cover:

- Customer instruction/education
- Installation
- Set up adjustments
- Cosmetic damage
- Damage due to acts of God, such as power surges
- Accident(s)
- Misuse, unintentional or intentional
- Abuse, unintentional or intentional
- Negligence
- Commercial purposes/use, including but not limited to use in a place of business or in communal areas of a multiple dwelling condominium or apartment complex, or otherwise used in a place of other than a private home.
- Modification of any part of the Product, including the antenna
- Damage due to incorrect operation or maintenance
- Connection to an incorrect voltage or power supply
- Outages, static or other problems with over-the-air reception of the television broadcast signals.
- Attempted repair by any person not authorized by Warrantor to service the Product
- Products sold "as is" or "with all faults"

- Consumables, including but not limited to batteries (i.e. AA, AAA, C etc.)
- Products where the factory applied serial number has been altered or removed
- Loss or Theft of this product or any part of the product
- Failures or Damage caused by any contact including but not limited to liquids, gels or pastes.
- Up to three (3) pixel failures (dots that are dark or incorrectly illuminated) grouped in an area smaller than one tenth (1/10) of the display size or up to five (5) pixel failures throughout the display. (Pixel based displays may contain a limited number of pixels that may not function normally.)
- Problems with delay in motion or action of video images while playing first-person style video games.

REPAIR REPLACEMENT AS PROVIDED UNDER THIS WARRANTY IS YOUR EXCLUSIVE REMEDY FOR BREACH OF WARRANTY. WARRANTOR SHALL NOT BE LIABLE FOR ANY INCIDENTAL OR CONSEQUENTIAL DAMAGES FOR THE BREACH OF ANY EXPRESS OR IMPLIED WARRANTY ON THIS PRODUCT, INCLUDING, BUT NOT LIMITED TO, LOST DATA, LOSS OF USE OF YOUR PRODUCT, LOST BUSINESS OR LOST PROFITS. WARRANTOR MAKES NO OTHER EXPRESS WARRANTIES WITH RESPECT TO THE PRODUCT, ALL EXPRESS AND IMPLIED WARRANTIES FOR THE PRODUCT, INCLUDING, BUT NOT LIMITED TO, ANY IMPLIED WARRANTIES OF AND CONDITIONS OF MERCHANTABILITY AND FITNESS FOR A PARTICULAR PURPOSE, ARE LIMITED IN DURATION TO THE WARRANTY PERIOD SET FORTH ABOVE AND NO WARRANTIES, WHETHER EXPRESS OR IMPLIED, WILL APPLY AFTER THE WARRANTY PERIOD. SOME STATES, PROVINCES AND JURISDICTIONS DO NOT ALLOW LIMITATIONS ON HOW LONG AN IMPLIED WARRANTY LASTS, SO THE ABOVE LIMITATION MAY NOT APPLY TO YOU. THIS WARRANTY GIVES YOU SPECIFIC LEGAL RIGHTS, AND YOU MAY ALSO HAVE OTHER RIGHTS, WHICH VARY FROM STATE TO STATE OR PROVINCE TO PROVINCE.

Product information:

<https://www.sharptvusa.com/support>

Product support (855) 544-2030

This product is manufactured for Best Buy China Ltd, as trustee for Best Buy China, and distributed and warranted by Best Buy Purchasing, LLC (7601 Penn Avenue South, Richfield, Minnesota, U.S.A. 55423-3645) under brand license by SHARP Corporation.

©2016 Best Buy China LTD. All rights reserved.

SHARP is a registered trademark of Sharp Corporation; used under license by Hisense International (Hong Kong) America Investment Co., Limited. All other trademarks are property of their respective owners.

SHARP®

Product information:
<https://www.sharptvusa.com/support>

This product is manufactured for Best Buy China Ltd, as trustee for Best Buy China, and distributed and warranted by Best Buy Purchasing, LLC (7601 Penn Avenue South, Richfield, Minnesota, U.S.A. 55423-3645) under brand license by SHARP Corporation.

©2016 Best Buy China LTD. All rights reserved.

SHARP is a registered trademark of Sharp Corporation; used under license by Hisense International (Hong Kong) America Investment Co., Limited

All other trademarks are property of their respective owners.