

SHARP • Roku TV

FHD 43" / 50" CLASS

(42.5" Diagonal)
(49.5" Diagonal)

LC-43LB601U
LC-50LB601U



FIND YOUR USER GUIDE ONLINE!

We are going green so a copy of your *User Guide* is not provided in the box but is available online. Go to: <https://www.sharphusa.com/support> Find your model. Under **Owners Manual**, find the language you want, then click **Download**. Your online *User Guide* opens.

V1
FINAL
FOR PRINT

Final flat size: 593.85 x 419.61 mm

QUICK SETUP GUIDE

1 START HERE

How do I attach the stands to my TV? (not for wall mounting)

You'll need: Phillips screwdriver and a soft surface to lay the TV on.
Carefully place your TV face-down on a cushioned, clean surface.
Align the TV stands with the screw holes on the bottom of the TV. Make sure that the arrows on the stands are pointing towards the front of the TV.
Secure the stands to the TV with the four provided screws.

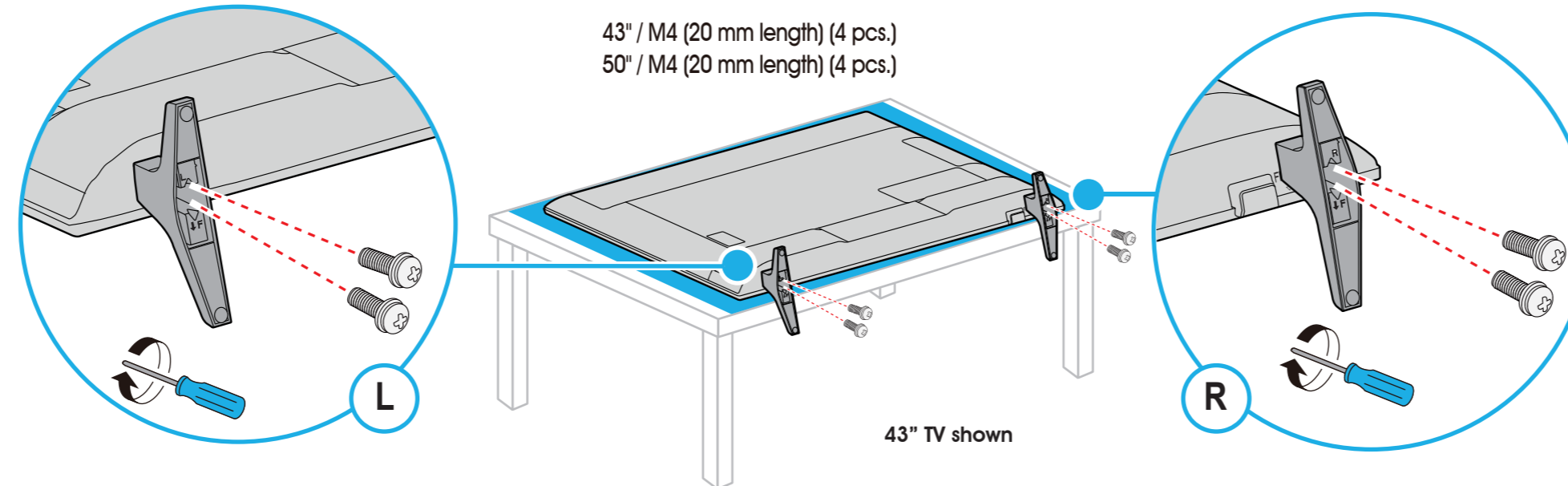

How do I prepare my TV for wall mounting? (not for use with the TV stands)

You'll need: Phillips screwdriver and a soft surface to lay the TV on.
A Carefully place your TV face-down on a cushioned, clean surface.
B See the instructions that came with your wall mount for more information about how to correctly mount your TV.

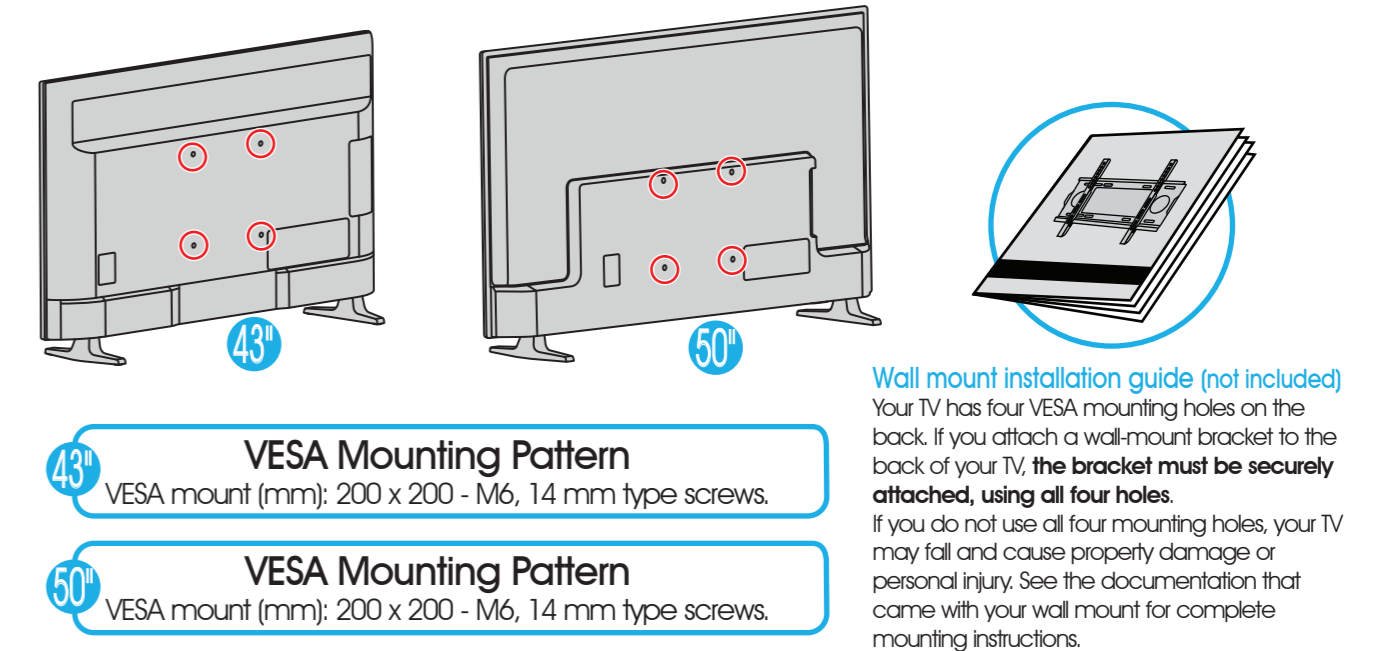

STOP!
Do not plug your power cord in until all other devices have been connected.

Included accessories

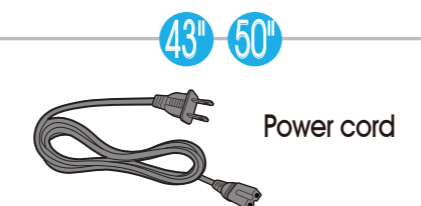
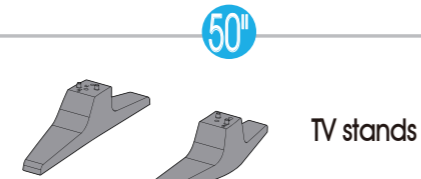
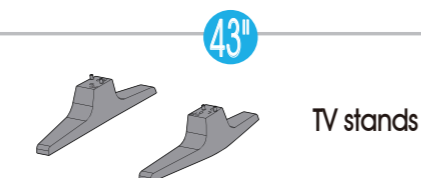

What you need (not included)

- A Phillips screwdriver
- Wireless router* (needed for streaming)
- Internet connection* (needed for streaming)

* Subscription or other payment may be required to access certain content.

Features

Front view

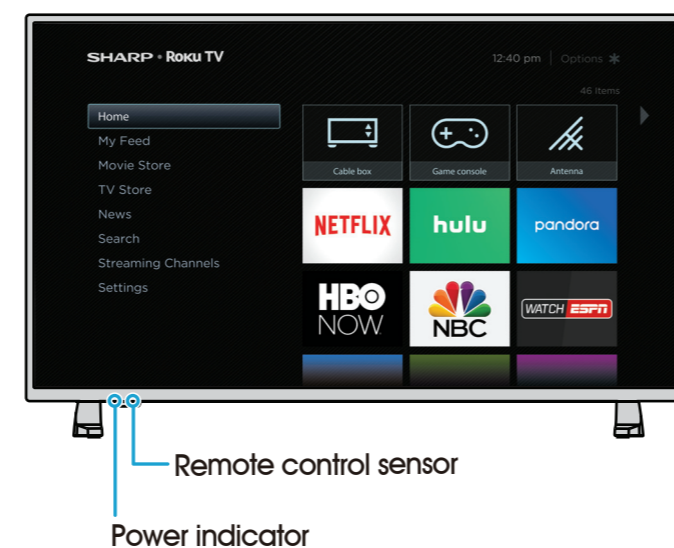

Back view

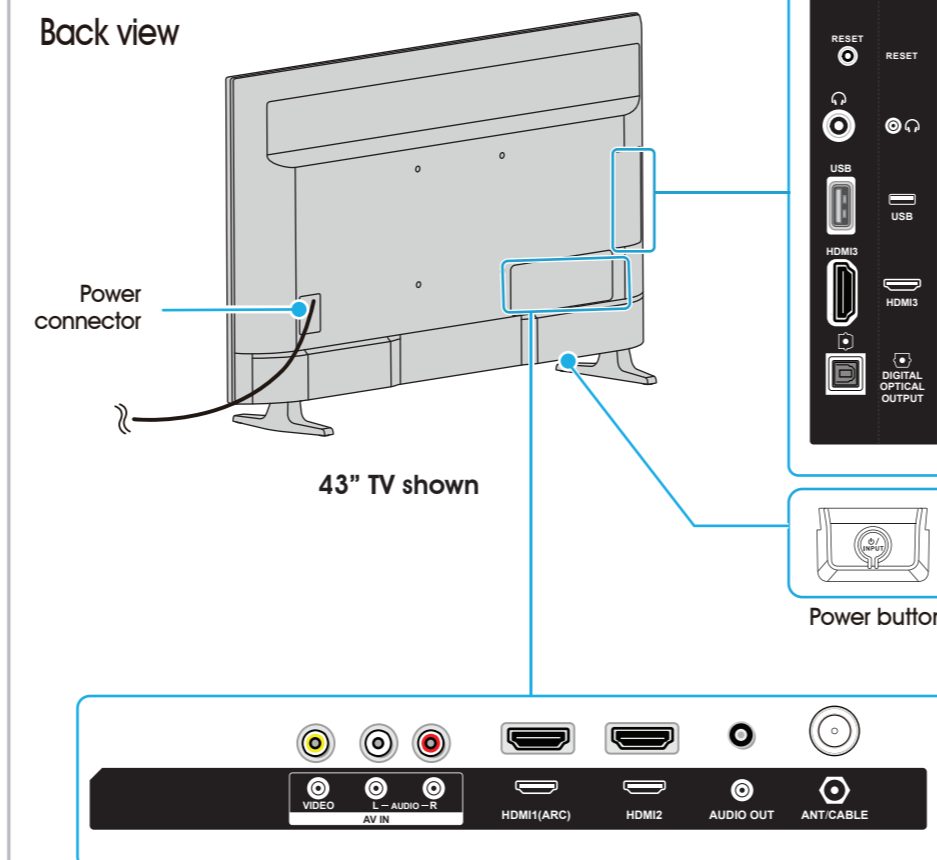

Note: Images do not necessarily represent the exact design of your television. Before using your new product, please read these instructions to prevent any damage.

2 MAKING CONNECTIONS

How do I watch TV or connect a device such as a DVD or Blu-ray disc player, game console, or tablet?

Using an HDMI cable (BEST)
43" TV shown

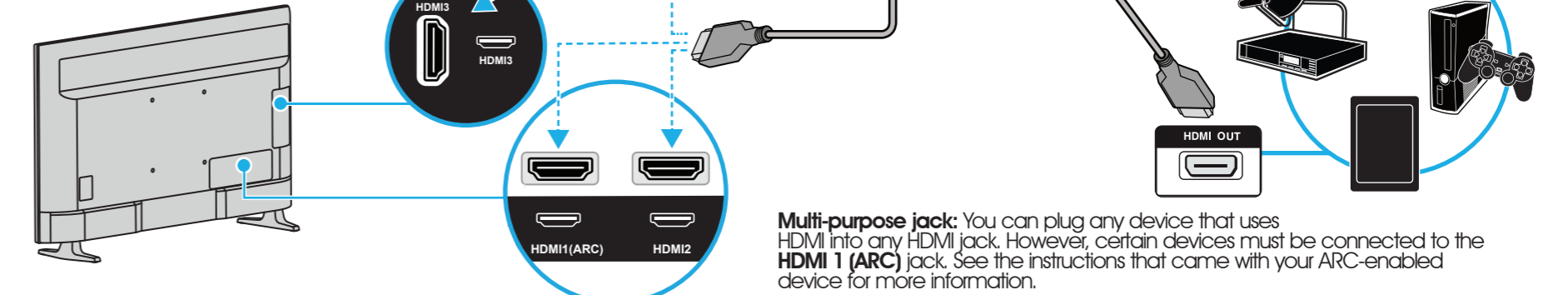

Using an AV cable (GOOD)
43" TV shown



How do I connect my TV to an antenna or cable wall jack?



3 CONNECTING AUDIO DEVICES

How do I connect my TV to external speakers?

Using digital audio OR analog audio

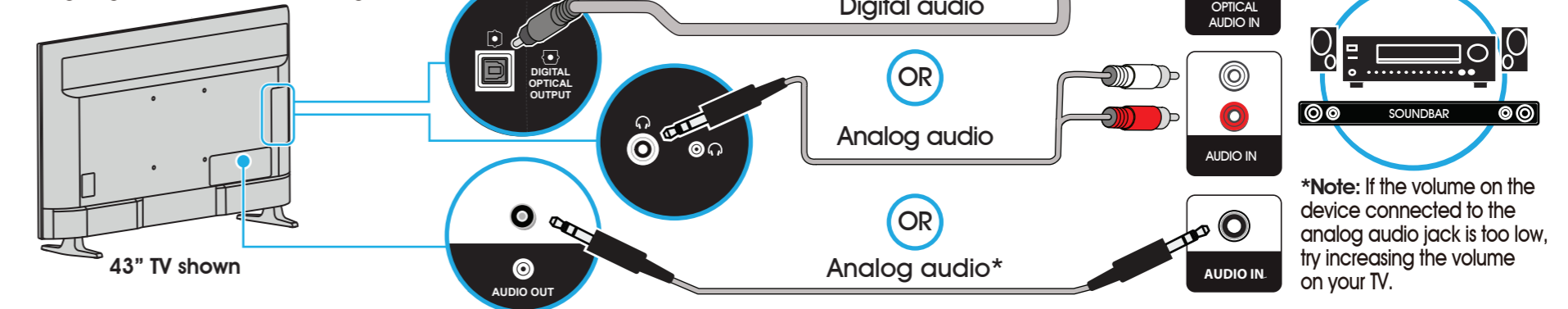

4 TURNING ON MY TV

When can I turn on my TV?

The best time to turn on your TV is after you have connected all devices and either attached the TV stand or wall-mounted your TV.

When your television is in place:

- 1 Plug one end of the power cord into the power connector on the back of your TV and the other end into a power outlet.
- 2 Remove the remote control cover and install the batteries.
- 3 Press  (power) on your remote control.
- 4 Follow the on-screen instructions.

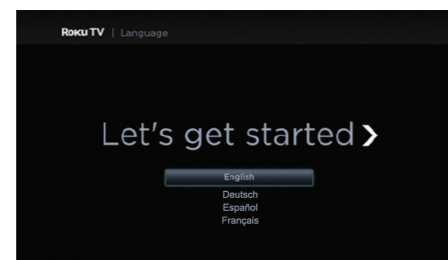
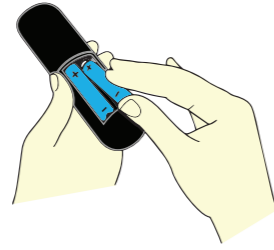
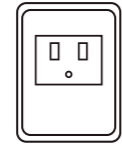

5 COMPLETE GUIDED SETUP (OPTIONAL)

Establish your network connection.

- 1 Your TV automatically detects your wireless network, so have your network name and password handy and follow the easy on-screen instructions.
- 2 You'll be prompted to create your Roku account online at <https://my.roku.com/link>. Your TV will generate a unique code that links your TV to your new account.
Note: Roku accounts are free, and while a valid credit card number is not required, providing your card information makes renting and purchasing entertainment a breeze. You won't be charged unless you agree to the terms and cost of the content.
- 3 Once connected to your account, your TV will automatically update with the latest software, and you can start streaming immediately.
- 4 If you aren't ready to connect your TV to a wireless network, you can still use it as a regular TV.

6 OPTIONAL

Watching local broadcast TV. How do I scan for channels?

If you connected a cable or satellite box, skip this step.
If you connected your TV to an antenna or cable wall jack (no box):

- 1 When the setup wizard is complete, select the **ANTENNA TV** tile from the Home screen.
- 2 Follow the on-screen instructions.
- 3 Whenever you want to watch TV, select this tile.

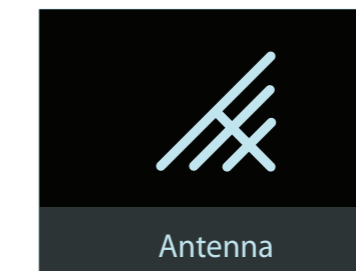

SHARP • Roku TV

TROUBLESHOOTING

Having trouble completing the guided setup?
Don't worry, it's usually an easy fix.

If you cannot see a picture on your TV

- Make sure that your TV and the device you want to watch (cable box, Blu-ray player, game console, etc.) are turned on and plugged into a working wall outlet.
- Make sure that your power cable is connected.

If you cannot connect to your wireless home network during guided setup

- Make sure that the correct wireless network name is selected.
- Make sure that the wireless network password is correctly entered (password is case sensitive).
- Improve the wireless signal by rotating the router slightly (even a few inches can help).

If you cannot hear sound

- Make sure that the TV volume is turned up and not on mute.
- Try only the TV speakers by disconnecting any connection to audio devices (like headphones or audio video receivers).

If the TV remote control isn't working

- Remove any obstruction and point the remote at the TV's remote control sensor (see Features).
- Try a fresh set of batteries.
- If the status light on the front of your TV flashes once each time you press a remote button, the problem is not with the remote.
- Unplug the TV and plug it back in.

One-year limited warranty

Visit <https://www.sharptvusa.com/support>

Need additional help?

See your online *User Guide!* This comprehensive guide includes everything from basic how-to steps to more advanced features. Go to: <https://www.sharptvusa.com/support>
Find your model. Under *Owners Manual*, find the language you want, then click *Download*. Your online *User Guide* opens.

We're here for you.

<https://www.sharptvusa.com/support>
For customer service, call: 855-544-2030
©2018 Best Buy China LTD.

All rights reserved. SHARP is a trademark of Sharp Corporation; used under license by Hisense International (Hong Kong) America Investment Co., Limited.

CONNECTING BRINGS OUT YOUR TV'S FULL POTENTIAL!

You'll have access to thousands of streaming channels.*



Make any night a movie night

Access more than 500,000 movies and TV episodes across major streaming services like Netflix, Hulu, Amazon Video, VUDU, and more. Choose from free, rental, and subscription services.

Stream sports on the big screen.

Choose from over 140 sports channels like WatchESPN, FOX Sports Go, NBA, NFL, MLB, WWE, CBS Sports, and more.*

Explore your passions

In addition to popular streaming channels like HBO NOW, SHOWTIME, PBS KIDS, and FOX NOW, your Sharp • Roku TV also offers hundreds of streaming channels to fuel your passions – including fitness, cooking, religion, outdoors, international programming, and much more.

Enjoy tons of free channels and free trials

Your Sharp • Roku TV has hundreds of popular free channels like Crackle, CBS News, PBS, VEVO, and more. Plus, free trials** to popular subscription services like HBO NOW, SHOWTIME, Netflix, Amazon Video, and Hulu.

*Subscription or other payment may be required to access certain channels. Content may not be available in all areas in which the Sharp • Roku TV is sold and channel availability is subject to change.

**Cancel before your free trial ends to avoid subscription fees. A credit card may be required.

ROKU, ROKU TV, and the ROKU logo are trademarks and the property of Roku, Inc. Other channel logos, brand, and product names are trademarks or registered trademarks of their respective holders.

USING YOUR REMOTE CONTROL

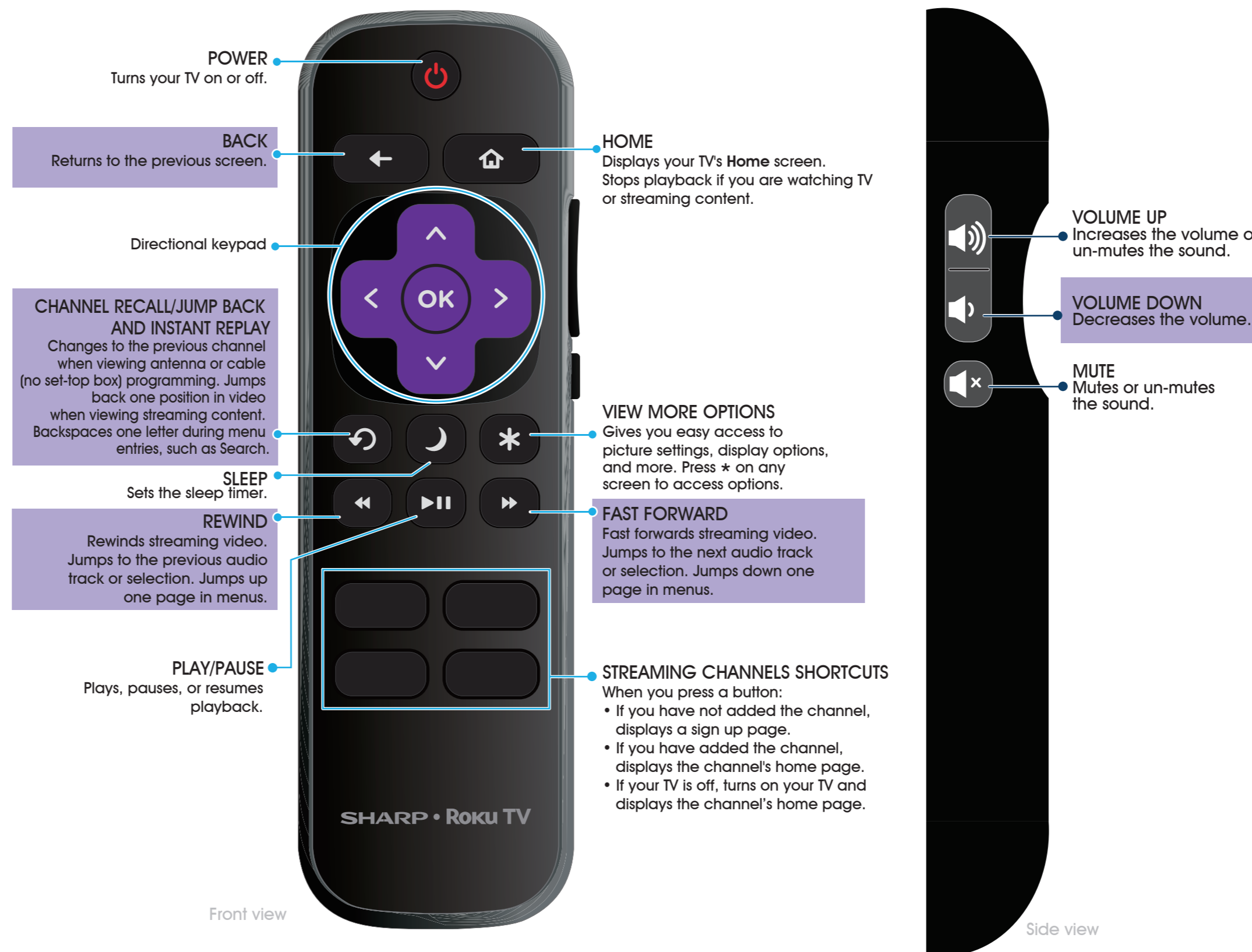

Using your cable set-top box or satellite receiver remote as a universal remote.

If you prefer to use your cable set-top box or satellite receiver remote as a universal remote, please refer to the manual that your cable or satellite service provided. It will include instructions on how to program their remote to your television. You can find codes that work with your Sharp • Roku TV and the most common cable and satellite provider's universal remote controls at www.roku.com/universallremote.