

Final flat size: 23.38 x 16.52 in.
593.85 x 419.61 mm

V1
FINAL
FOR PRINT

SHARP • Roku TV

UHD 50" / 55" CLASS

(49.5" Diagonal)
(54.6" Diagonal)

LC-50LBU711U
LC-55LBU711U

QUICK SETUP GUIDE

1 START HERE

How do I attach the stands to my TV? (not for wall mounting)

You'll need: Phillips screwdriver and a soft surface to lay the TV on.
Carefully place your TV face-down on a cushioned, clean surface.
Align the TV stands with the screw holes on the bottom of the TV. Make sure that the arrows on the stands are pointing towards the front of the TV.
Secure the stands to the TV with the four provided screws.

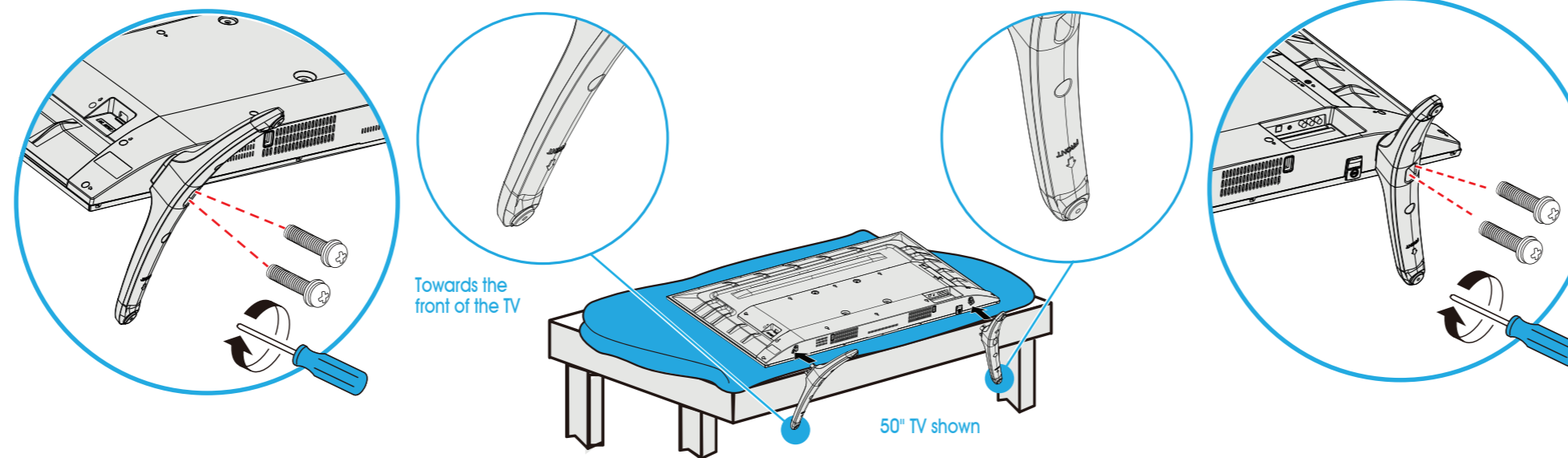

How do I prepare my TV for wall mounting? (not for use with the TV stands)

You'll need: Phillips screwdriver and a soft surface to lay the TV on.
A Carefully place your TV face-down on a cushioned, clean surface.
B See the instructions that came with your wall mount for more information about how to correctly mount your TV.

OR

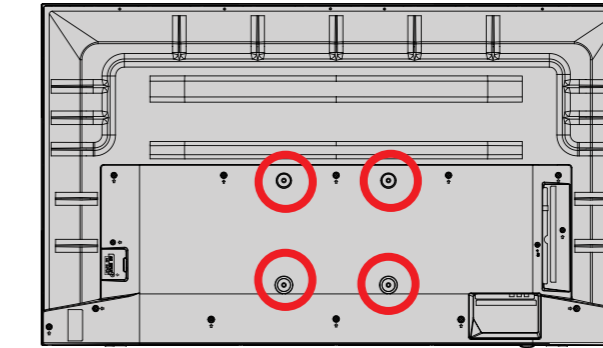

50" TV shown

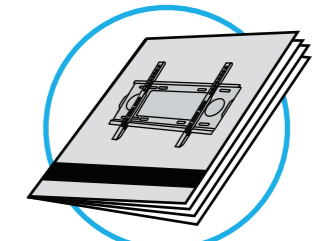

Wall mount installation guide (not included)
Your TV has four VESA mounting holes on the back. If you attach a wall-mount bracket to the back of your TV, the bracket must be securely attached using all four holes.
If you do not use all four mounting holes, your TV may fall and cause property damage or personal injury. See the documentation that came with your wall mount for complete mounting instructions.

50" VESA Mounting Pattern
VESA mount (mm): 200 x 200 -M6, VESA mount screw length = 13mm (min)

55" VESA Mounting Pattern
VESA mount (mm): 300 x 200 -M6, VESA mount screw length = 13mm (min)

STOP!

Do not plug your power cord in until all other devices have been connected.

Included accessories



Remote control and two AAA batteries

50" 55"

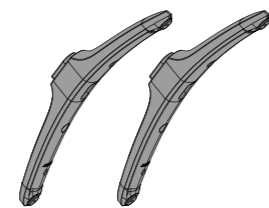

TV stands



M4 (20 mm length) (4 pcs.)

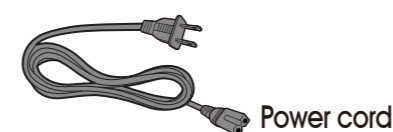

Power cord

What you need (not included)



A Phillips screwdriver



Wireless router* (needed for streaming)



Internet connection* (needed for streaming)

* Subscription or other payment may be required to access certain content. A computer, tablet, or smartphone is needed for setup.

Features

Front view

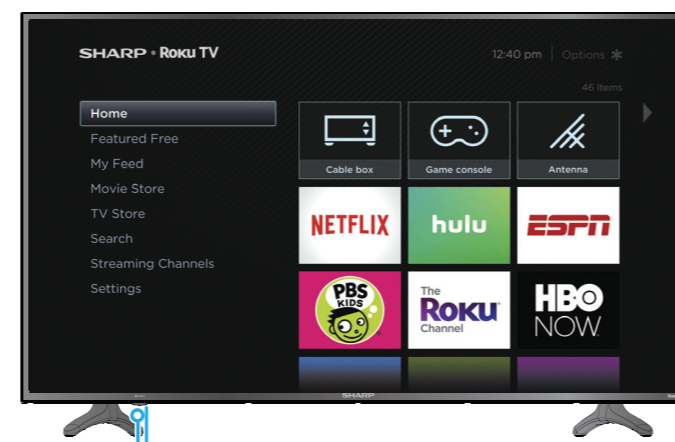

INPUT
Power indicator
Remote control sensor

Back view

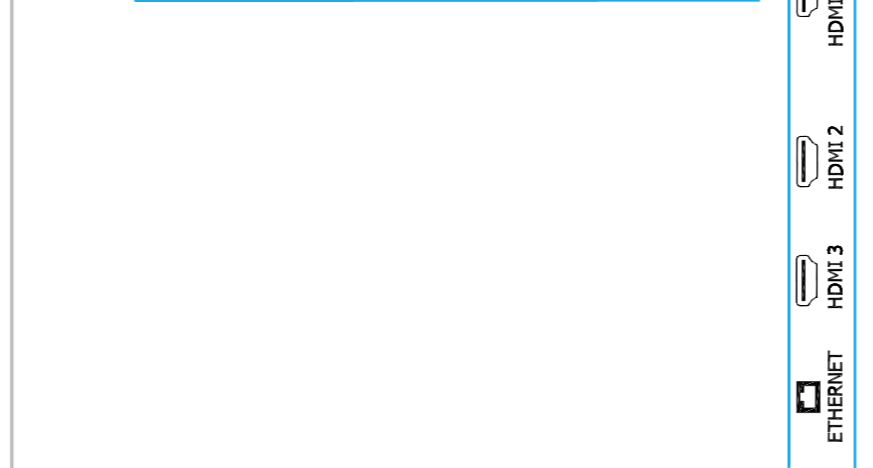
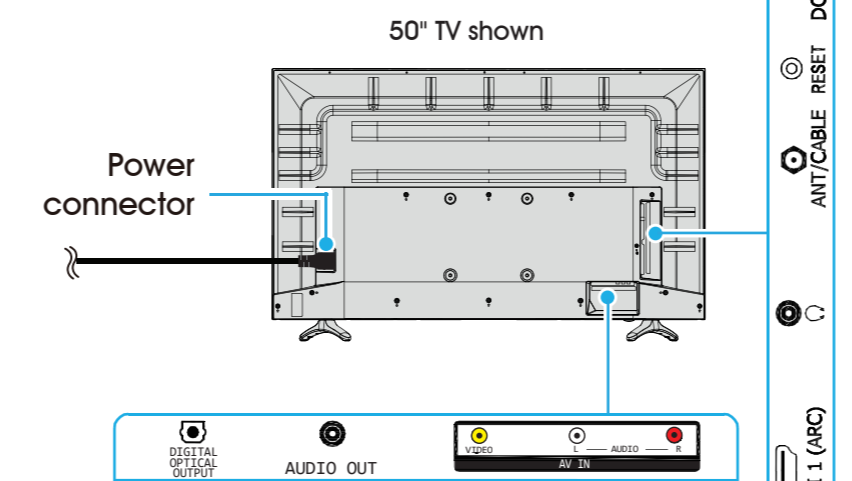

Note: Images do not necessarily represent the exact design of your television. Before using your new product, please read these instructions to prevent any damage.

2 MAKING CONNECTIONS

How do I watch TV or connect a device such as a DVD or Blu-ray disc player, game console, or tablet?

Using an HDMI cable (BEST)

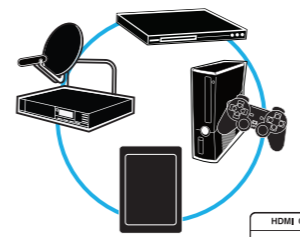

Multi-purpose jack: You can plug any device that uses HDMI into any HDMI jack. However, certain devices must be connected to the HDMI 1 (ARC) jack. See the instructions that came with your ARC-enabled device for more information.

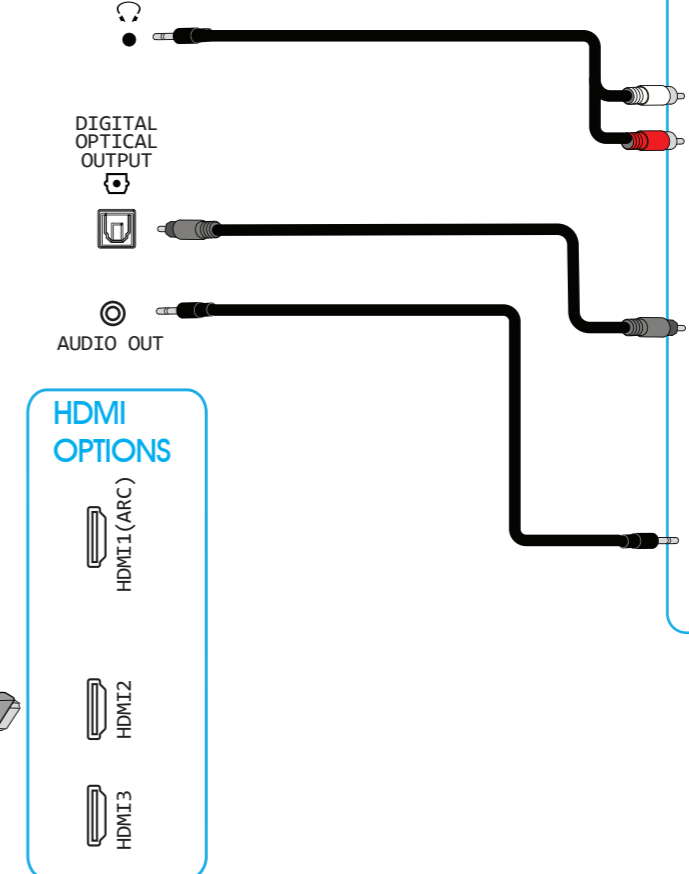

AUDIO OPTIONS

Connecting my TV to external speakers.

USING ANALOG AUDIO*

USING DIGITAL AUDIO

USING ANALOG AUDIO

*Note: If the volume on the device connected to the analog audio jack is too low, try increasing the volume on your TV.

Using an AV cable (GOOD)

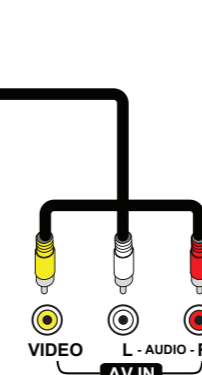
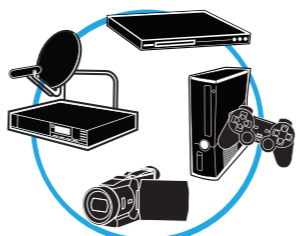

Coaxial (good video quality)

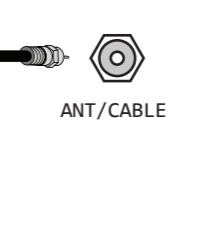
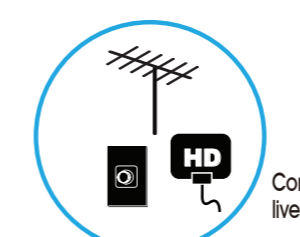

ETHERNET (OPTIONAL)

Note: You have to connect to either a LAN or Wi-Fi to access the internet. See back for additional info.

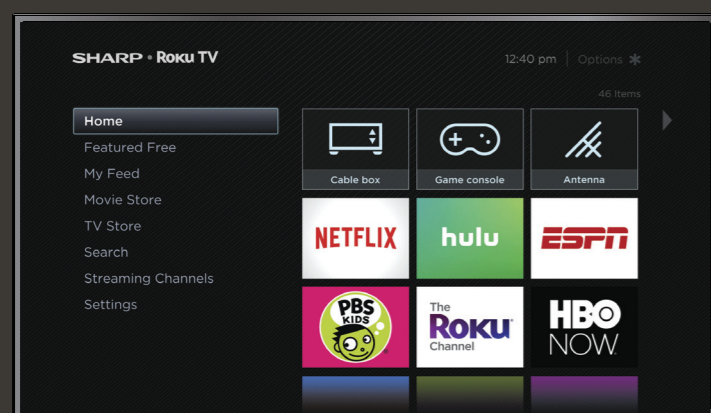

FIND YOUR USER GUIDE ONLINE!

We are going green so a copy of your User Guide is not provided in the box but is available online. Go to: <https://www.sharptvusa.com/support> Find your model. Under Owners Manual, find the language you want, then click Download. Your online User Guide opens.

3 TURNING ON MY TV

When can I turn on my TV?

The best time to turn on your TV is after you have connected all devices and either attached the TV stand or wall-mounted your TV.

When your television is in place:

- 1 Plug one end of the power cord into the power connector on the back of your TV and the other end into a power outlet.
- 2 Remove the remote control cover and install the batteries.
- 3 Press (power) on your remote control.
- 4 Follow the on-screen instructions.

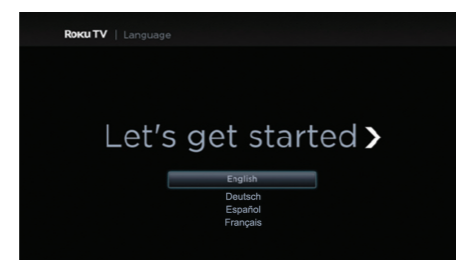
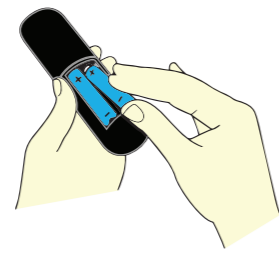
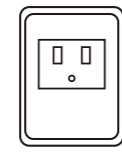

4 COMPLETE GUIDED SETUP (OPTIONAL)

Establish your network connection.

- 1 Your TV automatically detects your wireless network, so have your network name and password handy and follow the easy on-screen instructions.
- 2 You'll be prompted to create your Roku account online at <https://my.roku.com/link>. Your TV will generate a unique code that links your TV to your new account.
Note: Roku accounts are free, and while a valid credit card number is not required, providing your card information makes renting and purchasing entertainment a breeze. You won't be charged unless you agree to the terms and cost of the content.
- 3 Once connected to your account, your TV will automatically update with the latest software, and you can start streaming immediately.
- 4 If you aren't ready to connect your TV to a wireless network, you can still use it as a regular TV.
Note: Roku does not charge for activation support – **beware of scams.**

5 OPTIONAL

Watching local broadcast TV. How do I scan for channels?

If you connected a cable or satellite box, skip this step.
If you connected your TV to an antenna or cable wall jack (no box):

- 1 When the setup wizard is complete, select the **ANTENNA TV** file from the Home screen.
- 2 Follow the on-screen instructions.
- 3 Whenever you want to watch TV, select this file.

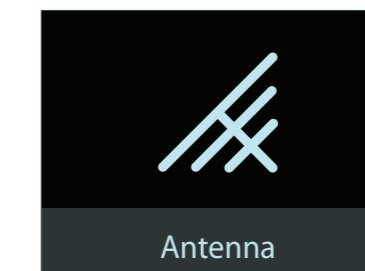

SHARP • Roku TV

TROUBLESHOOTING

Having trouble completing the guided setup?
Don't worry, it's usually an easy fix.

- If you cannot see a picture on your TV**
- Make sure that your TV and the device you want to watch (cable box, Blu-ray player, game console, etc.) are turned on and plugged into a working wall outlet.
 - Make sure that your power cable is connected.

- If you cannot connect to your wireless home network during guided setup**
- Make sure that the correct wireless network name is selected.
 - Make sure that the wireless network password is correctly entered (password is case sensitive).
 - Improve the wireless signal by rotating the router slightly (even a few inches can help).

- If you cannot hear sound**
- Make sure that the TV volume is turned up and not on mute.
 - Try only the TV speakers by disconnecting any connection to audio devices (like headphones or audio video receivers).

- If the TV remote control isn't working**
- Remove any obstruction and point the remote at the TV's remote control sensor (see Features).
 - Try a fresh set of batteries.
 - If the status light on the front of your TV flashes once each time you press a remote button, the problem is not with the remote.
 - Unplug the TV and plug it back in.

One-year limited warranty

Visit <https://www.sharptvusa.com/support>

Need additional help?

See your online *User Guide!* This comprehensive guide includes everything from basic how-to steps to more advanced features. Go to: <https://www.sharptvusa.com/support>
Find your model. Under *Owners Manual*, find the language you want, then click *Download*. Your online *User Guide* opens.

We're here for you.

<https://www.sharptvusa.com/support>
For customer service, call: 1-855-544-2030
©2019 Best Buy China LTD.

All rights reserved. SHARP is a trademark of Sharp Corporation; used under license by Hisense International (Hong Kong) America Investment Co., Limited.

CONNECTING BRINGS OUT YOUR TV'S FULL POTENTIAL!

You'll have access to thousands of streaming channels.*

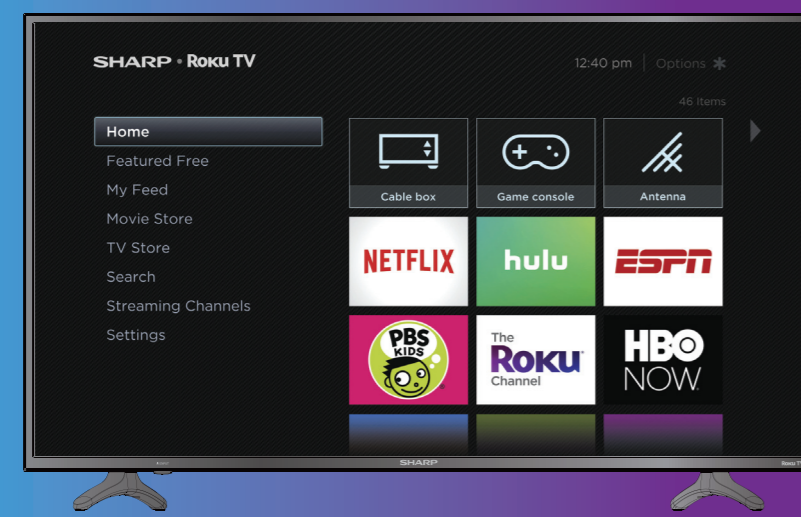

Make any night a movie night

Access more than 500,000 movies and TV episodes across free, paid, and rental streaming channels like Netflix, Hulu, Amazon Video, VUDU, and more.

Stream sports on the big screen

Choose from over 140 sports channels like ESPN+, FOX Sports Go, NBA, NFL, MLB, WWE, CBS Sports and more.*

Explore your passions

In addition to popular streaming channels like HBO NOW, SHOWTIME, PBS KIDS, and FOX NOW, your Sharp Roku TV also offers hundreds of streaming channels to fuel your passions – including fitness, cooking, religion, outdoors, international programming, and much more.

Enjoy tons of free entertainment

Your Sharp Roku TV has hundreds of free channels like YouTube, Crackle, CBS News, and The Roku Channel offering movies, TV, sports, music and more.

*Subscription or other payment may be required to access certain channels. Content may not be available in all areas in which the Sharp Roku TV is sold and channel availability is subject to change. ROKU, ROKU TV and the ROKU logo are the trademarks of Roku, Inc. All other trademarks and logos herein are the property of their respective owners.

USING YOUR REMOTE CONTROL

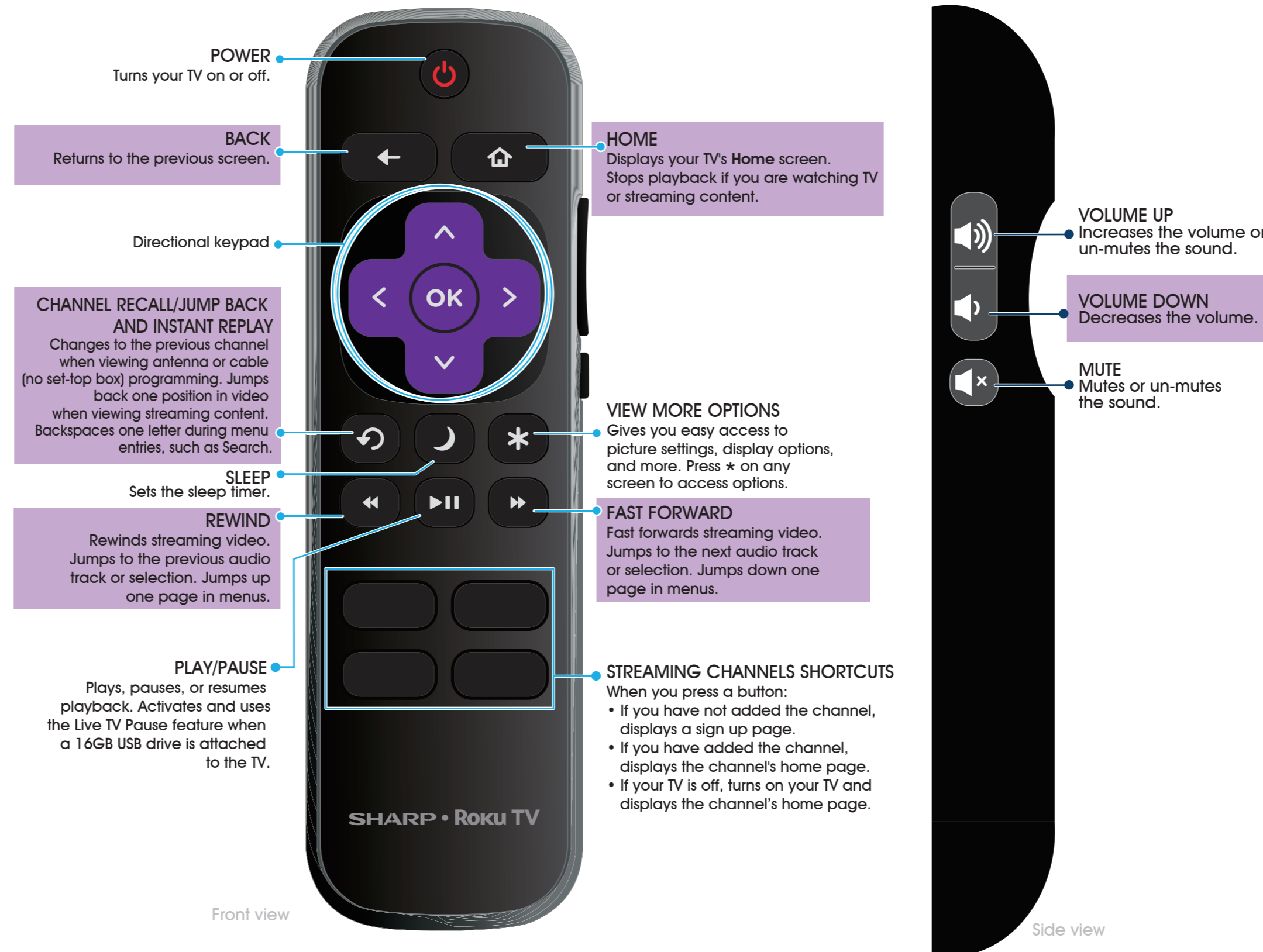

Using your cable set-top box or satellite receiver remote as a universal remote.

If you prefer to use your cable set-top box or satellite receiver remote as a universal remote, please refer to the manual that your cable or satellite service provided. It will include instructions on how to program their remote to your television. You can find codes that work with your Sharp • Roku TV and the most common cable and satellite provider's universal remote controls at www.roku.com/universalremote.