

ES-G1752C4-1



SHARP®



4K UHD Smart TV

Quick Start Guide

LC-43Q7000U LC-55Q7000U
LC-43Q7020U LC-55Q7020U
LC-43Q7050U LC-55Q7050U
LC-43Q7060U LC-55Q7060U
LC-43Q7070U LC-55Q7070U
LC-43Q7080U LC-55Q7080U
LC-43Q7003U LC-55Q7003U
LC-50Q7000U LC-65Q7000U
LC-50Q7020U LC-65Q7020U
LC-50Q7050U LC-65Q7050U
LC-50Q7060U LC-65Q7060U
LC-50Q7070U LC-65Q7070U
LC-50Q7080U LC-65Q7080U
LC-50Q7003U LC-65Q7003U

Help SHARP improve the environment by reducing paper waste.
For detailed instructions and feature descriptions, access the full User Manual online.
Before using the TV, please read this guide carefully and keep it for future reference.

© 2018 Hisense Company Ltd. All Rights Reserved.

All material in this Quick Start Guide is the property of Hisense Company Ltd. and its subsidiaries, and is protected under US and International copyright and/or other intellectual property laws. Reproduction or transmission of the materials, in whole or in part, in any manner, electronic, print, or otherwise, without the prior written consent of Hisense Company Ltd., is a violation of Hisense Company Ltd. rights under the aforementioned laws.

No part of this publication may be stored, reproduced, transmitted or distributed, in whole or in part, in any manner, electronic or otherwise, whether or not for a charge or other or no consideration, without the prior written permission of Hisense Company Ltd. Requests for permission to store, reproduce, transmit or distribute materials may be made in writing to the following address:

USA: Hisense USA Corporation
7310 McGinnis Ferry Road
Suwanee, GA 30024

CANADA: Hisense Canada Co., Ltd
2283 Argentia Road, Unit 16
Mississauga, ON, Canada L5N 5Z2

MEXICO: Hisense Mexico S. de R.L. de C.V.
Blvd. Miguel de Cervantes Saavedra No 301
Torre Norte Piso 2, Col. Ampliación Granada
Miguel Hidalgo, Ciudad de México, C.P. 11520

"Sharp™", "Aquos™", "Quattron™" and any and all other Sharp product names, logo's, slogans or marks are registered trademarks owned exclusively by Sharp Corporation.

"Hisense™", and any and all other Hisense product names, logo's, slogans or marks are registered trademarks and intellectual property rights of Hisense Company Ltd. and its subsidiaries.

This product is sold to you under one or more license agreements between Sharp Corporation and Hisense International (Hong Kong) America Investment Co. Ltd. All other trademarks are the property of their respective holders.





Table of Contents

Register Your TV!	1
Packaged Contents	2
Buttons and Ports on the TV	3
Attach the TV Stand or Wall Mount Bracket	5
Connect Devices to your TV	8
Establish a Network Connection.....	10
Buttons on your TV Remote	12
Begin Using your Remote.....	13
Power on the TV	14
Complete the First-Time Setup Menu.....	15
Begin to Enjoy your TV	16
Product Specifications	17
Quick Problem-Solving Tips	18
Certification and Compliance.....	19

Register Your TV!

Congratulations on the purchase of your new TV! This Quick Start Guide will walk you through a few easy steps to set up your TV. For detailed instructions, access the User Manual on the support pages listed below.

Because we value your business, we want to keep you in the know of 'all things SHARP'. Using your mobile phone, scan the Registration page QR code to register your TV. Depending on the make and model of your phone, you may need to download a QR code scanning app.

Country	Customer Care Center	SHARP Support Page	REGISTER YOUR TV
U.S.A	<ul style="list-style-type: none"> • Phone: 1-888-935-8880 • Hours of Operation: Monday - Friday: 9 AM to 9 PM EST Saturday - Sunday: 9 AM to 6 PM EST • Service Email: support@sharptvusa.com 	http:// www.sharptvusa.com /support 	www.sharptvusa.com/ support/productreg.asp 
CANADA	<ul style="list-style-type: none"> • Phone: 1-855-271-6271 • Hours of Operation: Monday - Friday: 8 AM to 8 PM EST • Service Email: Canadasupport@sharp-canada.ca 	 http://www.sharp-canada. ca/support/	No need to register
MEXICO	<ul style="list-style-type: none"> • Phone: 01-800-999-7277 • Hours of Operation: Monday - Friday 9:00-18:00 • Service Email: servicio@SHARPTV.com.mx 	http://www.SHARPTV.com. mx/support/ *Scan to download user manual 	http://www.SHARPTV. com.mx/support/product Reg.asp 

Disclaimer: This Quick Start Guide is intended as a general guideline to help you set up your TV. Images throughout this document are for illustrative purposes only and may differ from the actual product.

Packaged Contents

Your package in which you purchased your new TV contains the following items:

- 2 AAA batteries
- Quick Start Guide
- 4 screws (M4×25) (65")
- 4 screws (M4×20) (50"/55")
- 4 screws (M4×40) (43")
- A left and right leg that forms the TV stand
- Important Safety Information and Warranty Card
- Remote Control
- Power Cord

IMPORTANT:

To prevent accidentally discarding items that came with your TV, be sure to **check ALL of the foam** in the carton box.

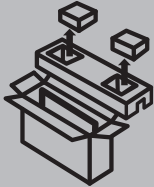

- Please check foam for accessories before discarding.
- Veuillez vérifier la mousse pour qu'il n'y ait pas d'accessoires avant de la jeter.
- Antes de desechar la espuma, asegúrese de retirar todos los accesorios.

Required tools and devices

- Wireless router (not included) for Internet connectivity
- Phillips screwdriver (not included) to secure the TV stand
- HDMI and other types of cables (not included) to connect external devices to the TV
- Wall mount bracket (not included) if you prefer to mount the TV to the wall

Buttons and Ports on the TV

TV Side View

Back View of the TV (43"/50"/55")

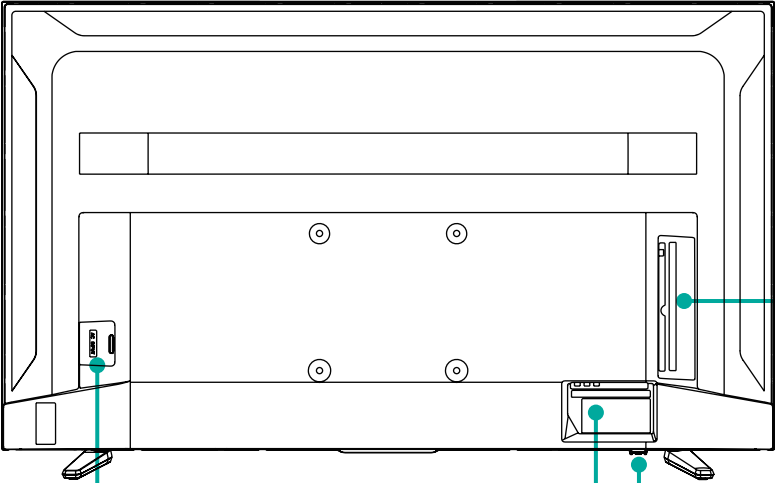

Power Input

TV Bottom Panel

TV Back View



TV Side View

Back View of the TV (65")

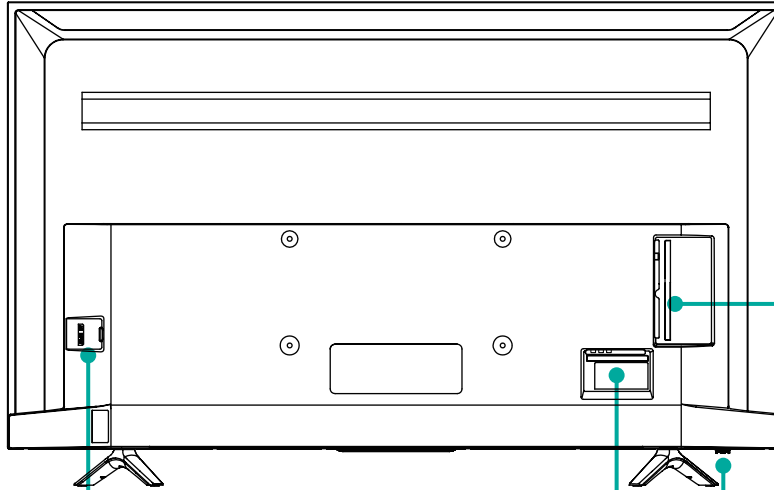

Power Input

TV Back View



TV Bottom Panel



STEP 1. Attach the TV Stand or Wall Mount Bracket (not included)

Attach the TV Stand (For steps to attach the wall mount see page 7)

CAUTION:

- Be sure to disconnect the A/C power cord before installing a stand or Wall-Mount brackets.
- The LED display is very fragile and must be protected at all times when installing the legs that form the stand. Be sure to protect the TV screen from getting scratched or damaged by any hard objects. In addition, DO NOT exert pressure on the front of the TV at any time because it could crack.

For(43"/50"/55")

To attach the left and right leg that forms the stand:

1. Carefully place your TV face-down on a soft, flat surface to prevent the TV from being damaged or the screen from getting scratched.
2. Remove the 2 legs from the foam and then insert the legs into the bottom slots of the TV.
3. Use the screws that came inside the carton with your TV to secure each leg tightly.

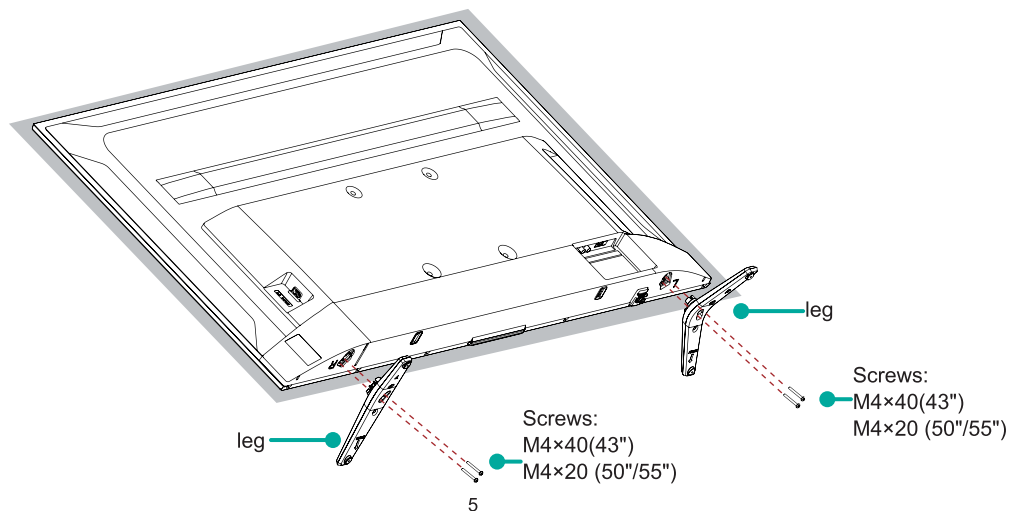

For(65")

To attach the left and right leg that forms the stand:

1. Carefully place your TV face-down on a soft, flat surface to prevent the TV from being damaged or the screen from getting scratched.
2. Remove the 2 legs from the foam and then insert the legs into the bottom slots of the TV.
3. Use the screws that came inside the carton with your TV to secure each leg tightly.

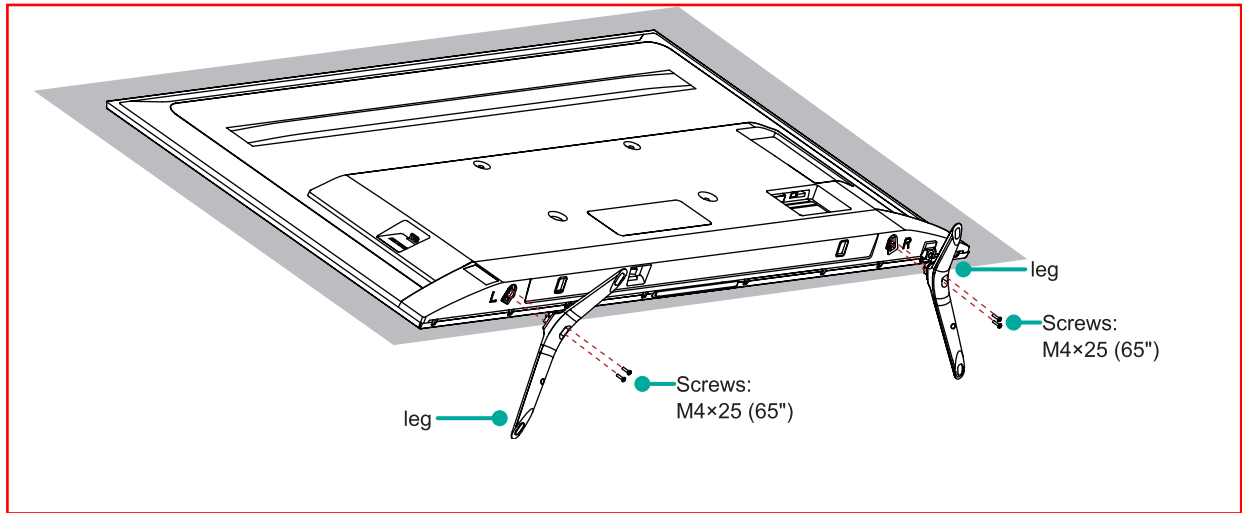

Attach the Wall Mount Bracket (not included)

Before you begin the third-party manufacturer instructions, be sure to do the following things:

1. Place the TV face down on a clean, safe and cushioned surface.
2. Remove the TV stand if you already attached it.
3. Place the spacers (not included) in the corresponding bracket holes.

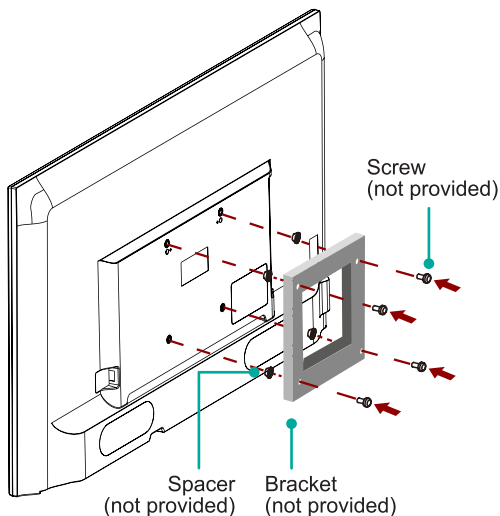

CAUTION:

- When you attach the mount, be sure to use the spacers (provided by the third-party manufacturer) between the TV and the bracket.

- To prevent internal damage to the TV and ensure it is mounted securely, be sure to use fixing screws (not provided) that are 8.0-10.0 mm(43") / 9.5-11.5 mm(50"/55"/65") in length when measured from the attaching surface of the mounting hook.

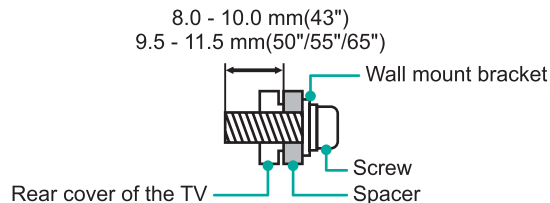

Wall mount hole pattern VESA (mm)	200 × 200 (43"/50") 300 × 200 (55") 400 × 200 (65")
Wall mount screw size (mm)	M6













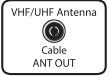











Follow instructions provided with the Wall mount bracket.









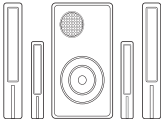

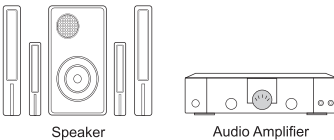

- To complete the installation, please contact the wall-mount manufacturer or the retailer from which you purchased the TV.
- The selected screws are 8.0-10.0 mm(43") / 9.5-11.5 mm(50"/55"/65") in length when measured from the attaching surface of the rear cover.

NOTE: The diameter and length of the screws differ depending on the wall mount bracket model.

STEP 2. Connect Devices to your TV

Check to ensure that you have selected the right cables for the ports and that they are connected securely. Loose connections can affect the quality of the picture image and color.

TV label		Port	Cable	External Equipment	Brief Description
ANT/CABLE				 Antenna  VHF/UHF Antenna Cable ANT OUT	Connect an outdoor VHF/UHF antenna.
HDMI				 VCR  DVD Player/Recorder  Video Camera  Set-top Box  Satellite Receiver  Satellite antenna cable	Connect a High Definition Multimedia Interface (HDMI) cable from an external device.
AV IN	VIDEO		 Yellow	 Video Camera  Set-top Box  Satellite Receiver  Satellite antenna cable	Connect a composite video cable and left-right audio cables from an external AV device.
	L		 White		
	R		 Red		
DIGITAL AUDIO OUT				 Audio Amplifier  Speaker	Connect an optical cable from an external digital audio system.

TV label	Port	Cable	External Equipment	Brief Description
AUDIO OUT 				Connect headphones to hear audio from the TV. Headphones with microphones are not supported.
			 Speaker Audio Amplifier	Connect an audio adapter (not provided) from an external analog audio system.
USB 				Connect a USB device for browsing photos, music and movies. Hard disks with a total current consumption or impulse current consumption greater than 500mA are not supported.
LAN			 LAN	Connect an Ethernet cable to access a network or the Internet. The TV also has a wireless connectivity feature.
SERVICE		This port is not available for you to connect an external device. It can only be used by our factory for testing purposes.		

STEP 3. Establish a Network Connection

1. Press the [**≡**] button on the remote control, press [**▼**] button to select **Settings** and then press [**OK**] to enter the Settings menu.
2. Select **Network** → **Network Configuration**.

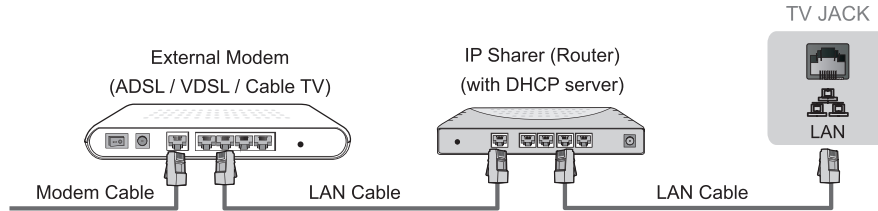

Establish a wired network connection

Automatically obtain an IP address

1. Select **Wired LAN**. The TV will automatically obtain an IP address and connect to the network.

NOTE: The default option of IP Settings Mode is DHCP.

2. If the connection fails then "**Disconnected**" will display for the Ethernet status. Retry or enter the **IP Settings**, select **Manual** to input the information again.

Manually enter the IP address

1. Select **Manual**.
2. Enter the IP Address, Netmask, Gateway, DNS Server 1 and DNS Server 2 in the menu. Next, select **Connect**.

Establish a wireless network connection

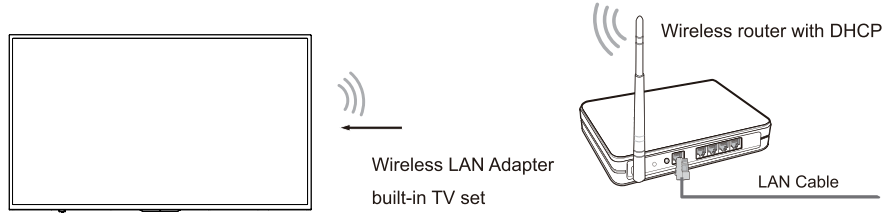



The TV can directly receive network signals via wireless router



1. Select **Wireless**. The list of networks will be displayed automatically.
2. Select a wireless network from the list, input the password and select **Connect**.
3. If the network connection does not appear in the list, select **Refresh** to refresh the list or select **Add** to manually enter SSID and Security mode selection.

Close the network connection

Select **Off**. The network connection will close.

Buttons on your TV remote

<i>BUTTON</i>	<i>DESCRIPTION</i>
	Power on / off
INPUT	Change TV input source
Number	Enter Channels / input numbers
CC	Turn Closed Captioning On/Off and CC On When Mute
—	Dash button / Select a digital sub-channel
— (Red / Green / Yellow / Blue)	Special function buttons
TV	Live TV
	The button for the Quick setup menu
^ / v / < / >	D-pad (up/down/left/right navigation buttons)
OK	Confirmation button
BACK	Return to the previous place in the menu or app

<i>BUTTON</i>	<i>DESCRIPTION</i>
EXIT	Exit the application
	Display the Home screen
+ VOL —	Volume (up/down)
+ CH —	Channel (up/down)
	Mute and restore sound
MTS	Set the audio language(MTS)
	Media content control function buttons
NRT	Choose to leave the Video description feature On or Off
APPS	All apps

NOTE: The buttons that appear on your remote may differ from the descriptions that we've provided for context.

STEP 4. Begin Using your Remote

1. Slide the back cover to open the battery compartment of the remote control.



Gently push and slide

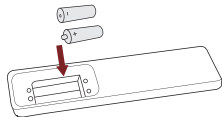

Insert the batteries

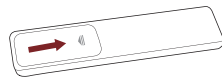

Gently push and slide

2. Insert two AAA size batteries. Make sure to match the (+) and (-) ends of the batteries with the (+) and (-) ends indicated in the battery compartment.
3. Replace the battery compartment cover.

Important Information about the remote and batteries:

- **Discard batteries in a designated disposal area. Do not throw them into a fire.**
- **Remove old batteries immediately to prevent them from leaking into the battery compartment.**
- **If you do not intend to use the remote control for a long time, then remove the batteries.**
- **Battery chemicals can cause a rash. If the batteries leak, clean the battery compartment with a cloth. If chemicals touch your skin then wash it immediately.**
- **Do not mix old and new batteries.**
- **Do not mix alkaline, standard (carbon-zinc) or rechargeable (NiCd, NiMH, etc.) batteries.**
- **Do not continue using the remote if it gets warm or hot.**

Call our Support Center immediately on the support website.

Remote Control Range Information

- The remote control can work at a distance of up to 26 feet in front of the TV set.
- It can work at a 30 degree horizontal or vertical angle.

Program Your Universal Cable or Satellite Remote Control to Operate Your New Television (only for USA)

If you would like to program your other household remote controls to your new television, please refer to the User's Manual supplied by your Cable or Satellite provider. The Cable or Satellite providers' User's Manuals should include instructions on how to program their remote to your television.

A list of codes for the most common Cable and Satellite providers are listed below. Use the code that is associated with your Cable or Satellite provider (if applicable).

DIRECTV.....0178, 10178, 10019, 10748, 11314, 11660, 11710, 11780, 12049, 10171, 11204, 11326, 11517, 11564, 11641, 11963, 12002, 12183

Time Warner Cable.....386, 0178, 10178, 400, 450, 461, 456, 0748, 1463, 0463, 10463

Comcast.....0178, 10178, 10463, 11463, 10748, 11314, 11660, 10171, 11204, 11326, 11517, 11641, 11780, 11785, 11892, 11963, 12002

Cox Communications.....0178, 10178, 1326, 1463

Dish Network.....505, 627, 538, 720, 659

If the code associated with your Cable or Satellite provider is not listed, does not work or you cannot locate the instructions to program your remote, call your local Cable or Satellite provider's

customer service center.

If your Cable or Satellite provider does not have a code available, please contact us at one of the phone numbers on Page 1.

Using Your Cable Set-top Box or Satellite Receiver Remote as a 'Universal' Remote

If you prefer to use your Cable Set-top Box or Satellite Receiver Remote as a 'Universal Remote', then visit the Support page to view a list of the codes.

STEP 5. Power on the TV

Plug the power cord into a power outlet.

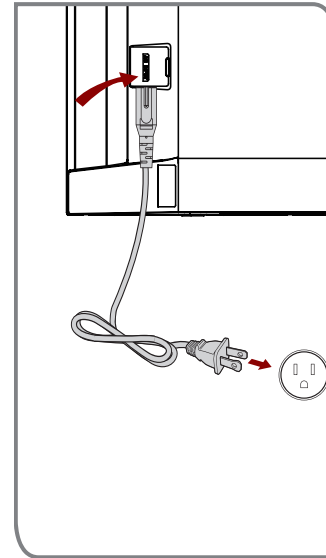

Press the **Power button** (⏻) on the remote to turn on the TV. A splash screen that shows the logo appears. Next, the First-Time Setup Menu begins by prompting you to choose your **Language**, **Region**, and **Time Zone**.



STEP 6. Complete the First-Time Setup Menu

After the splash screen that shows the logo appears, begin the first-time setup menu.

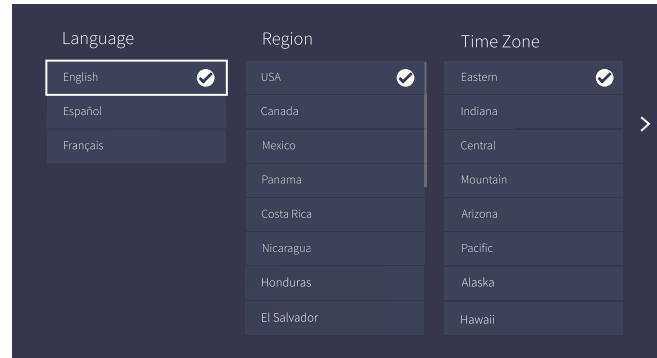

Screen	Task
Language and Location	<ul style="list-style-type: none"> Using the D-pad arrows of your remote, choose your Language, Region and Time Zone.
End User License Agreement	<ul style="list-style-type: none"> Choose Decline or Agree. When choose Agree, select Continue icon and press [OK].
Usage Mode	<ul style="list-style-type: none"> Select Home Mode (which appears by default). Note: 'Store Mode and Store Mode(Video Demo Only)' should only be selected by Retailers who plan to demonstrate the TV.
Network Connection	<ul style="list-style-type: none"> If your TV does not automatically detect an Ethernet connection, then use a wireless network. Select your network from the list that displays, input the password. Also you can add a hidden network.

Screen	Task
Product Registration	<ul style="list-style-type: none"> • Registering helps keep your product humming with software updates, product support and our warranty.
Last step of TV setup	<ul style="list-style-type: none"> • You are at the last step of TV setup. If you have not connected network, you can select 'Set up network' or 'Use without network'. If you have connected network, Congratulations! You have completed TV setup. Start to use.

STEP 7. Begin to Enjoy your TV

Your Smart TV is easy to use and brag-worthy!

Now that you've completed the first-time setup menu, the **Home** screen is your starting point for navigating the TV. Gone are the days where your TV only provides one way for you to be entertained. This showpiece provides you the convenience of watching a program on a live channel, accessing Video on Demand to watch a movie and many other entertainment options.

Using your remote, press the **Home** button to begin enjoying your TV.

Disclaimer: Subscriptions or other payments may be required to access content through some applications. Some or all of the included or downloaded application services in this Sharp, Aquos or Quattron device may not function depending on the Internet connection, local limitations of included applications or other reasons outside of the Licensor's or Manufacturers control. ALL LICENSORS AND THE MANUFACTURER EXPRESSLY DISCLAIM RESPONSIBILITY FOR ANY APPLICATION SERVICE FROM FUNCTIONING AT ANY TIME, FOR CONTENT IN ANY APPLICATION SERVICE, FOR DISRUPTIONS OF SERVICE, LOCAL OR REGIONAL LIMITATIONS, WARRANTIES OF TITLE, NO INFRINGEMENT, AND FOR IMPLIED WARRANTIES OF MERCHANTABILITY OR FITNESS FOR A PARTICULAR PURPOSE. By purchasing this device, you accept such Disclaimer without any claim on any Licensor and/or the Manufacturer at any time and in any territory.

PRODUCT SPECIFICATIONS

Model Name		LC-43Q7000U	LC-50Q7000U	LC-55Q7000U	LC-65Q7000U
		LC-43Q7020U	LC-50Q7020U	LC-55Q7020U	LC-65Q7020U
		LC-43Q7050U	LC-50Q7050U	LC-55Q7050U	LC-65Q7050U
		LC-43Q7060U	LC-50Q7060U	LC-55Q7060U	LC-65Q7060U
		LC-43Q7070U	LC-50Q7070U	LC-55Q7070U	LC-65Q7070U
		LC-43Q7080U	LC-50Q7080U	LC-55Q7080U	LC-65Q7080U
		LC-43Q7003U	LC-50Q7003U	LC-55Q7003U	LC-65Q7003U
		Dimension (W × H × D)	Without Stand	38.2 × 22.6 × 2.8 inches (970 × 573 × 71 mm)	44.4 × 26.0 × 2.9 inches (1 127 × 661 × 73 mm)
With Stand	38.2 × 24.0 × 8.7 inches (970 × 608 × 220 mm)		44.4 × 27.7 × 9.5 inches (1 127 × 703 × 241 mm)	48.9 × 30.0 × 9.5 inches (1 242 × 761 × 241 mm)	57.5 × 35.7 × 13.1 inches (1 460 × 908 × 334 mm)
Weight	Without Stand	17.4 lbs (7.9 kg)	25.8 lbs (11.7 kg)	30.9 lbs (14.0 kg)	43.2 lbs (19.6 kg)
	With Stand	18.1 lbs (8.2 kg)	26.9 lbs (12.2 kg)	32.0 lbs (14.5 kg)	44.8 lbs (20.3 kg)
Active Screen Size (Diagonal)		42.5 inches	49.5 inches	54.6 inches	64.5 inches
Screen Resolution		3 840 × 2 160	3 840 × 2 160	3 840 × 2 160	3 840 × 2 160
Audio Power		7 W + 7 W	10 W + 10 W	10 W + 10 W	15 W + 15 W
Power consumption		95 W	100 W	160 W	205 W
Power Supply		120 V ~ 60 Hz			
Picture Quality		Screen resolution: 3840 x 2160, UHD Upscaler			
HDMI Input		RGB / 60 Hz (640×480, 800×600, 1 024×768), YUV / 60 Hz (480i, 480p, 720p, 1 080i, 1 080p) 3 840x2 160/60Hz, 3 840x2 160/24Hz, 3 840x2 160/25Hz, 3 840x2 160/30Hz			
Receiving systems	Analog	NTSC			
	Digital	ATSC / QAM			
Ports		3 HDMI ports, 1 USB port, 1 LAN port for Ethernet, 1 Digital Audio Output, 1 RF Input, 1 Earphone Audio Output, 1 RCA Composite Video Input , 1 Left/Right Audio Input for Composite			

Disclaimer: All products, product specifications, and data are subject to change without notice to improve reliability, function, design or otherwise. HDR viewing experience will vary by model, content availability and Internet connection.

QUICK PROBLEM-SOLVING TIPS

When you experience an issue with your TV, turn it off and on again. If this does not resolve the problem, then refer to the tips below. If the problem is still not resolved, then contact us at one of the phone numbers on Page 1.

ISSUES	POSSIBLE SOLUTIONS
No sound or picture	<ul style="list-style-type: none">• Check if the power cord is plugged into a powered AC outlet.• Press the  Power button on the remote control to activate the unit from 'Standby' mode.• Check to see if the LED light is on or not. If it is, then the TV is receiving power.
I have connected an external source to my TV and I get no picture and/or sound.	<ul style="list-style-type: none">• Check for the correct output connection on the external source and for the correct input connection on the TV.• Make sure you have made the correct selection for the input mode for the incoming signal.
When I turn on my TV, there is a delay for a few seconds before the picture appears. Is this normal?	<ul style="list-style-type: none">• Yes, this is normal. The TV is initializing and searching for previous setting information.
The picture is normal but there is no sound	<ul style="list-style-type: none">• Check the volume settings.• Check if 'Mute' mode is set to On.
Sound but no picture or black and white picture	<ul style="list-style-type: none">• If the picture is black and white, unplug the TV from the AC outlet and replug it after 60 seconds.• Check that the Color is set to 50 or higher.• Try different TV channels.
The sound and/or picture is distorted or appears wavy	<ul style="list-style-type: none">• An electric appliance may be affecting the TV. Turn off any appliances that are nearby and move it farther away from the TV.• Insert the power plug of the TV set into another power outlet.
The sound and picture is blurry or cuts out	<ul style="list-style-type: none">• If using an external antenna, check the direction, position and connection of the antenna.• Adjust the direction of your antenna or reset or fine tune the channel.
A horizontal or vertical stripe appears on the picture and/or the picture is shaking	<ul style="list-style-type: none">• Check if there is an appliance or electric tool nearby that is causing interference.
The plastic cabinet makes a "clicking" type of sound	<ul style="list-style-type: none">• The 'click' sound can occur when the temperature of the television changes. This change causes the television cabinet to expand or contract, which makes the sound. This is normal and the TV is OK.
The remote control does not work	<ul style="list-style-type: none">• Confirm that TV still has power and is operational.• Change the batteries in the remote control.• Check if the batteries are correctly installed.

Certification and Compliance

FCC Notice

This device has been tested and found to comply with the limits for a Class B digital device pursuant to Part 15 of the FCC Rules. These limits are designed to provide reasonable protection against harmful interference in a residential installation. This device generates, uses, and can radiate radio frequency energy and, if not installed and used in accordance with the instructions, may cause harmful interference to radio communications.

However, there is no guarantee that interference will not occur in a particular installation. If this device does cause harmful interference to radio or television reception, which can be determined by turning the device off and on, the user is encouraged to try to correct the interference by one or more of the following measures:

- Reorient or relocate the receiving antenna.
- Increase the separation between the device and receiver.
- Connect the device into an outlet on a circuit different from that to which the receiver is connected.
- Consult the dealer or an experienced radio/TV technician for help.

NOTE: The manufacturer is not responsible for any radio or TV interference caused by unauthorized modifications to this equipment. Such modifications could void the user's authority to operate the equipment.

The Wi-Fi Module complies with FCC radiation exposure limits set forth for an uncontrolled environment. This device should be installed and operated with a minimum distance of 20 centimeters between the radiator and your body.



Manufactured under license from Dolby Laboratories. Dolby, Dolby Audio, and the double-D symbol are trademarks of Dolby Laboratories.



The terms HDMI and HDMI High-Definition Multimedia Interface, and the HDMI Logo are trademarks or registered trademarks of HDMI Licensing LLC in the United States and other countries.



For DTS patents, see <http://patents.dts.com>. Manufactured under license from DTS Licensing Limited. DTS, the Symbol, & DTS and the Symbol together are registered trademarks, and DTS TruSurround is a trademark of DTS, Inc. © DTS, Inc. All Rights Reserved.



©2018. All rights reserved. SHARP and the SHARP logo are registered trademarks of SHARP. Other brand and product names are registered trademarks of their respective owners.